

# CATALOGUE GÉNÉRAL

SUPPORTAGE ■ FIXATION ■ ASSEMBLAGE ■ OUTILLAGE ■ PROTECTION  
■ CHAMBRE FROIDE ■

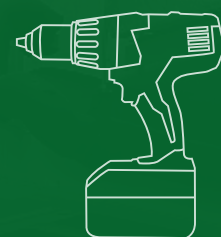

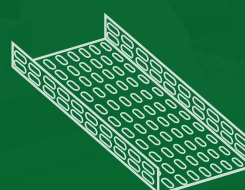
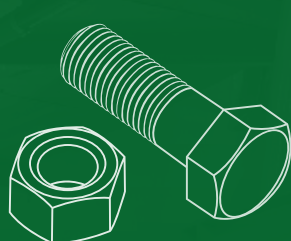
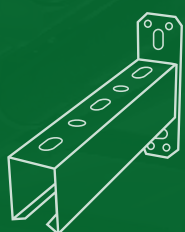

**Depuis 1988, POINT FIX s'affirme comme un PARTENAIRE ESSENTIEL de vos succès.**

Chaque jour, notre équipe commerciale est PRÉSENTE A VOS CÔTÉS, dans vos Bureaux d'Études, dans vos Ateliers, sur vos Chantiers pour vous aider à mener à bien vos travaux.

**POINT FIX, avec des partenaires prestigieux, soucieux d'être un PROFESSIONNEL de la FIXATION et du SUPPORTAGE, vous propose :**

- Un large choix de produits de supportage avec les conseils de mise en œuvre et les compétences techniques de spécialistes.
- Une gamme complète de fixations, adaptées à chaque besoin et bénéficiant de toutes les garanties de Bureaux de Contrôles Européens et Mondiaux.
- Une très grande variété de techniques d'assemblage mécanique et chimique.
- Un assortiment de machines, d'outillage et accessoires pour forer, percer, couper, rainurer, visser, assembler.
- Des services permanents comme L'AIDE AUX CALCULS, LES CONSEILS TECHNIQUES, LE SERVICE APRÈS-VENTE, L'ACCOMPAGNEMENT SUR VOS CHANTIERS...

Matthieu NAVARRO

## SUPPORTAGE

PROFIL SIMPLE 41	4	COQUILLES FROID	11
PROFIL DOUBLE 41	5	COLLIERS	12
PROFIL GAC & INOX	5	ACCESSOIRES COLLIERS	13
ACCESSOIRES 41	6	CHEVILLES/PATTE A VIS	13
ACCESSOIRES 41	7	ETRIERS/FEUILLARDS	14
BOULONNERIE 41	7	FIXATION SANITAIRE	15
PROFIL JUNIOR	8	ATTACHES/CROCHETS	15
ACCESSOIRES JUNIOR	8	ACCESS. CHEMIN CÂBLES	16
BOULONNERIE JUNIOR	8	CHEMIN CÂBLES	17
CONSOLES 41	9	CLIPS ET PINCES	18
SUPPORTAGE GAC & INOX	9	SILENT BLOC	18
COLLIERS ISO	10	SUPPORTS / GROUPES	19

## FIXATION

GOUJON D'ANCRAGE	20	CHEVILLE RESSORT	24
CHEVILLE FEMELLE FIC	20	COLLIERS SERRAGE	25
CHEVILLE LAITON	20	COLLIERS ELECTRIQUE	25
CHEVILLES UNIVERSELLE	21	CÂBLES SUSPEN. RAPIDE	25
CHEVILLES MATERIAUX	21		
CLOUEUR SENCO	21		
CHEVILLES NYLON	22		
CHEVILLES A FRAPPER	23		
CHEV BETON CELLULAIRE	23		
VIS BETON	23		
SCHELLEMENT CHIMIQUE	24		
BASCULE RESSORT	24		

## ASSEMBLAGE

VIS AUTOPERCEUSE	26	RALLONGE / MANCHONS	33
VIS AUTOPERC. FRAISEE	27	VISSERIE NYLON	33
VIS BOIS POZIDRIV	28	CACHES ECROUS	33
VIS METAUX 6 PANS	28	VIS PLAQUISTES	33
VIS AUTOTARAUDEUSE	28	INSERTS / OUTILLAGE	34
BOULON TRCC ZINGUE	29	RIVETS OUTILLAGE	35
VIS POELLIER ZINGUE	29	MASTIC/COLLE/MOUSSE	36
BOULON CHEMIN CÂBLE	29		
VIS BOIS 6 PANS	29		
TIGE FILETEE ZINGUE	30		
RONDELLES	30 / 31		
ECROUS	32		

## OUTILLAGE

SDS	37	ACCROCHAGE	42
ACCESSOIRES SDS	37	LUBRIFIANT	42
FORETS HSS	38	LAMPE A SOUDER	42
OUTIL DE COUPE	38	LAMES SCIE	43
TREPAN	39	RUBANS ADHESIFS	43
TREPAN/COURONNE	39	ECHELLES/ESCABEAUX	44
SCIE TREPAN	40	OUTILLAGE MAÇON	44
COFFRETS EMBOUTS	40	OUTILLAGE MAÇON	45
TRACEUR CHANTIER	41	OUTILLAGE PLAQUISTE	45
AEROSOLS	41	OUTILLAGE ELECTRICIEN	46
ENROULAGE/ECLAIRAGE	41	OUTILLAGE PLOMBIER	47
DISQUES	42	OUTILLAGE	48
		MESURE/TRAÇAGE	49

## PROTECTIONS

PROTECTION DES MAINS	50	HYGIENE	51
PROTECTION DU CORPS	50	SECURITE	51
PROTECTION DU VISAGE	50		
PROTECTION DE LA TÊTE	50		
PROTECTION DES PIEDS	50		
PROTECTION DE L'OUÏE	51		
PROTECTION RESPIRAT.	51		

## CHAMBRE FROIDE

ACCESSOIRES PANNEAUX	52	POLYANE	55
T ALU	52	PRIMAIRE BITUME	55
VISSERIE SPECIALISEE	53	MANCHON ISOLANT	55
MASTIC CHAMBRE FROIDE	53	PARE VAPEUR TURBO	55
SUSPENTES	54		
ECLISSES	54		
PIECES DE REGLAGES	54		
ROTULES	54		
KIT CEINTURAGE	54		
COULISSE POUR T	54		
PANNEAUX ISOLATION	55		

# DIMENSIONS - POIDS DES TUBES



## TUBE ACIER D'USAGE COURANT (série moyenne) pour série forte : appliquer au poids total (tube + eau) un coefficient 1,13

Ø pouce	DN mm	Ø ext mm	épaisseur série moyenne m	Poids à vide (kg/ml)	Poids d'eau (kg/ml)	Poids total (kg/ml)	Espacement des supports (kg/ml)	Ancienne désignation gaz (mm)
1/4"	8	13,5	2,3	0,65	0,06	0,71	1	8 x 13
3/8"	10	17,2	2,3	0,85	0,12	0,98	1,00	12 x 17
1/2"	15	21,3	2,6	1,2	0,2	1,4	1,50	15 x 21
3/4"	20	26,9	2,6	1,6	0,5	2,1	1,50	20 x 27
1"	25	33,7	3,2	2,5	0,6	3,1	2,00	26 x 34
1" 1/4	30	42,4	3,2	3,2	1	4,2	2,50	33 x 42
1" 1/2	40	48,3	3,2	3,6	1,4	5	2,50	40 x 49
2"	50	60,3	3,6	5,1	2,2	7,3	3,00	50 x 60
2" 1/2	65	76,1	3,6	6,5	3,7	10,2	3,00	66 x 76
3"	80	88,9	4	8,5	5,1	13,6	3,50	80 x 90
4"	100	114,3	4,5	12	9	21	4,00	102 x 114
5"	125	139,7	4,5	15	14	29	4,50	-
6"	150	168,3	4,78	19	20	39	5,00	-
8"	200	219,1	6,35	33	34	67	5,00	-
10"	250	273	6,35	42	53	95	6,00	-
12"	300	328,8	7,92	62	75	137	6,00	-
14"	350	355,6	7,92	68	91	159	6,00	-
16"	400	406,4	8,74	86	119	205	6,00	-
18"	450	457,2	9,52	105	151	256	6,00	-
20"	500	508	10,31	127	186	313	6,00	-
24"	600	609,6	11,13	165	271	436	6,00	-

Les valeurs de ce tableau ne sont données qu'à titre indicatif

## TUBE CUIVRE

Ø ext (mm)	10	12	15	18	22	28	35	42	54	64	70	74	80	104	125	131
Poids tube plein d'eau (kg/m)	0,30	0,38	0,52	0,67	0,90	1,60	2,21	2,90	4,90	6,30	7,22	7,88	8,90	13,55	21,72	22,97

Les valeurs de ce tableau ne sont données qu'à titre indicatif

## TUBE CUIVRE FRIGORISTE

Ø "	1/8"	1/4"	3/8"	1/2"	5/8"	3/4"	7/8"	1"	1-1/8"	1-1/4"	1-3/8"	1-1/2"
Ø ext (mm)	3,2	6,4	9,5	12,7	15,9	19,1	22,2	25,4	28,6	31,8	34,9	38,1
Ø "	1-5/8"	2"	2-1/8"	2-1/4"	2-1/2"	2-3/8"	2-5/8"	2-7/8"	3"	3-1/8"	3-3/8"	3-5/8"
Ø ext (mm)	41,3	50,8	54,0	57,2	63,5	70,0	67,0	73,0	76,2	80,0	88,9	92,0

Les valeurs de ce tableau ne sont données qu'à titre indicatif

## FORTE

DN (mm)	50	75	100	125	150	200	250	300
Ø ext	60	82	110	135	160	210	265	317

Les valeurs de ce tableau ne sont données qu'à titre indicatif

## ECARTEMENT MAXIMUM DES SUPPORTS

### Norme P41.203

Nature des tuyauteries	PLOMB		CUIVRE			FORTE /AMIANTE/ZINC
Position ou diamètre	horizontale	verticale	≤ 20mm	21 à 40 mm	≥ 41mm	Horizon ou vertical
Ecartement maxi	0,40m	0,50m	1,25m	1,80m	2,50m	1,00m

Les valeurs de ce tableau ne sont données qu'à titre indicatif

## ECARTEMENT MAXIMUM DES SUPPORTS

### Norme DTU 60-31

Nature des tuyauteries	PVC PRESSION		PVC PRESSION		
Position ou diamètre	12 à 20 mm	25 à 32 mm	40 à 50 mm	63 à 75 mm	90 à 125 mm
Ecartement maxi	0,50m	0,65m	1,00m	1,30m	2,00m

Les valeurs de ce tableau ne sont données qu'à titre indicatif

# SUPPORTAGE

## 135 PROFIL SIMPLE 41

1 kN = 100 Kg

• Protection : électrozingué ou galvanisé à chaud ou inox ou époxy poudre. Couleurs RAL au choix.

• 41 x 21 x 2

• Pour installation légère

• Perforation de 13 x 25 mm tous les 50 mm



Refs.	L (mm)	F		F		f=1/200L F (kN)	f=1/360L F (kN)	
		F max (kN)	f max (mm)	F max (kN)	f max (mm)			
4895T	500	1.28	1.70	2.57	2.10	-	-	
	1000	0.63	6.80	1.27	8.50	0.765	0.422	
	1500	0.42	15.40	0.84	19.10	0.334	-	
	2000	0.30	27.40	0.62	34.10	-	-	
	2500	0.24	43.20	0.48	53.20	-	-	
4896U	3000	0.19	62.40	0.39	76.70	-	-	
	4000	<b>Note de Calcul sur demande</b>						
4897V	5000	<b>Note de Calcul sur demande</b>						
	6000	<b>Note de Calcul sur demande</b>						

• 41 x 41 x 2

• Pour installation semi lourde

• Perforation de 13 x 25 mm tous les 50 mm



Refs.	L (mm)	F		F		f=1/200L F (kN)	f=1/360L F (kN)	
		F max (kN)	f max (mm)	F max (kN)	f max (mm)			
4898W	500	3.51	0.80	7.03	1.00	-	-	
	1000	1.75	3.20	3.50	4.00	-	1.492	
	1500	1.15	7.30	2.31	9.10	-	0.663	
	2000	0.86	13.00	1.72	16.20	0.672	0.373	
	2500	0.68	20.40	1.36	25.40	0.430	0.239	
4899X	3000	0.55	29.60	1.11	36.50	0.298	0.166	
	4000	<b>Note de Calcul sur demande</b>						
4900Y	5000	<b>Note de Calcul sur demande</b>						
	6000	<b>Note de Calcul sur demande</b>						

• 41 x 62 x 2,5

• Pour installation semi lourde

• Perforation de 13 x 25 mm tous les 50 mm

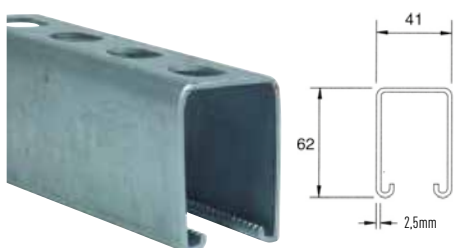

Refs.	L (mm)	F		F		f=1/200L F (kN)	f=1/360L F (kN)	F (kN)
		F max (kN)	f max (mm)	F max (kN)	f max (mm)			
1764M	500	8.29	0.50	16.57	0.70	-	-	20.081
	1000	4.14	2.30	8.29	2.80	-	-	15.245
	1500	2.76	5.20	5.52	6.50	-	3.434	10.507
	2000	2.07	9.20	4.14	11.50	3.473	1.923	7.789
	2500	1.66	14.40	3.31	18.00	2.217	1.236	6.141
	3000	1.38	20.80	2.76	26.00	1.540	0.853	5.042
	4000	<b>Note de Calcul sur demande</b>						
	5000	<b>Note de Calcul sur demande</b>						
	6000	<b>Note de Calcul sur demande</b>						

• 41 x 82 x 2,5

• Pour installation semi lourde

• Perforation de 13 x 25 mm tous les 50 mm

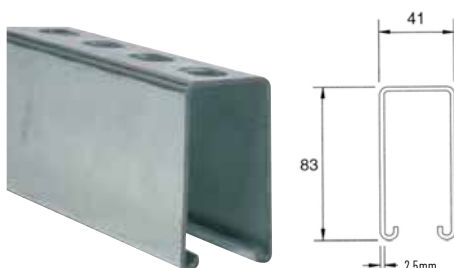

Refs.	L (mm)	F		F		f=1/200L F (kN)	f=1/360L F (kN)	F (kN)
		F max (kN)	f max (mm)	F max (kN)	f max (mm)			
1950F	500	11.71	0.30	20.00	1.00	-	-	19.620
	1000	5.84	1.50	11.68	1.90	-	-	16.422
	1500	3.87	3.40	7.75	4.30	-	-	8.182
	2000	2.89	6.10	5.78	7.60	-	4.120	5.719
	2500	2.29	9.60	4.58	11.90	-	2.639	4.326
	3000	1.89	13.80	3.78	17.20	-	1.834	3.453
	4000	<b>Note de Calcul sur demande</b>						
	5000	<b>Note de Calcul sur demande</b>						
	6000	<b>Note de Calcul sur demande</b>						



## 135 PROFIL DOUBLE 41

1 KN = 100 Kg

• Protection : électrozingué ou galvanisé à chaud ou inox ou époxy poudre. Couleurs RAL au choix.

• 41 x 83 x 2,5

• Pour installation lourde

• Perforation de 14 x 28 mm tous les 50 mm

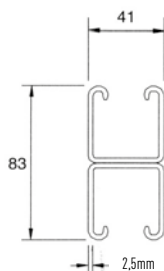

Refs.	L (mm)	F		F		f=1/200L F (kN)	f=1/360L F (kN)	F (kN)	
		F max (kN)	f max (mm)	F max (kN)	f max (mm)				
	500	-	-	-	-	-	-	27.311	
	1000	8.182	0.97	16.363	1.21	-	-	27.027	
	1500	4.091	3.87	8.182	4.84	-	7.034	24.584	
	2000	3.066	6.89	6.131	8.61	-	3.953	21.042	
	2500	2.453	10.77	4.905	13.46	4.552	2.531	17.452	
	3000	2.045	15.50	4.091	19.38	3.159	1.756	14.391	
	4000	<b>Note de Calcul sur demande</b>							
	5000								
	6000								

• 41 x 124 x 2,5

• Pour installation lourde

• Perforation de 14 x 28 mm tous les 50 mm

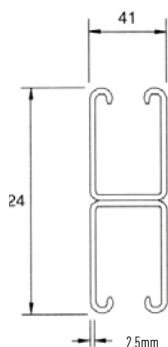

Refs.	L (mm)	F		F		f=1/200L F (kN)	f=1/360L F (kN)	F (kN)	
		F max (kN)	f max (mm)	F max (kN)	f max (mm)				
	500	-	-	-	-	-	-	34.590	
	1000	-	-	-	-	-	-	33.766	
	1500	7.873	2.46	15.745	3.07	-	-	31.667	
	2000	5.906	4.38	11.811	5.47	-	-	27.674	
	2500	4.724	6.83	9.477	8.54	-	7.671	23.299	
	3000	3.934	9.84	7.868	12.30	-	5.327	19.443	
	4000	<b>Note de Calcul sur demande</b>							
	5000								
	6000								

• 41 x 165 x 2,5

• Pour installation lourde

• Perforation de 14 x 28 mm tous les 50 mm

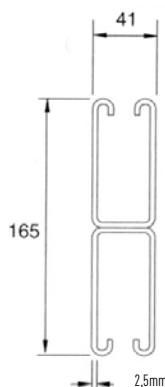

Refs.	L (mm)	F		F		f=1/200L F (kN)	f=1/360L F (kN)	F (kN)	
		F max (kN)	f max (mm)	F max (kN)	f max (mm)				
	500	-	-	-	-	-	-	34.129	
	1000	-	-	-	-	-	-	33.432	
	1500	10.222	1.44	20.444	1.80	-	-	32.010	
	2000	7.667	2.56	15.333	3.20	-	-	29.165	
	2500	6.131	4.00	12.263	5.00	-	-	25.467	
	3000	5.111	5.77	10.222	7.21	-	-	21.847	
	4000	<b>Note de Calcul sur demande</b>							
	5000								
	6000								

## 135 PROFIL SIMPLE 41 - GAC ET INOX

• 41 x 21 x 2

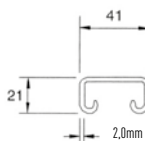

GAC ▶  
INOX ▶

Refs.	L (mm)	F		F		f=1/200L F (kN)	f=1/360L F (kN)
		F max (kN)	f max (mm)	F max (kN)	f max (mm)		
5408W	3000	0.55	29.60	1.11	36.50	0.298	0.166
6328K	3000						

• 41 x 41 x 2

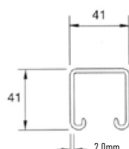

GAC ▶  
GAC ▶  
INOX ▶  
INOX ▶

5409X	3000						
0432Z	6000						
6196X	3000						
3596L	6000						

**Note de Calcul sur demande**

# SUPPORTAGE

## 138 ACCESSOIRES 41



Refs	JAMBE DE FORCE	Long
0406X		300 mm
0468M		600 mm



Ref	EQUERRE D'ASSEMBLAGE 90°
5681G	

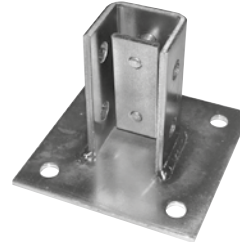

Refs	EMBASE LOURDE 41 X 41
3874W	
5889Z	INOX A2



Ref	EMBASE LOURDE 41 X 82
3875X	



Refs	PLAQUE VERROUILLAGE	Long
0853N		9 mm
0854P		11 mm
0855Q		13 mm



Ref	PIECE RACCORDEMENT 3 DIRECTIONS
5680F	



Ref	EQUERRE 41 ARTICULEE EN U
5522R	



Ref	PIECE ASSEMBLAGE D'ANGLE EQUERRE 90°
6616R	



Refs	APPLIQUE RAIL 41 VERTICALE
4518B	
6413P	GAC
2752R	INOX



Refs	APPLIQUE RAIL 41 HORIZONTALE
3414C	
2751Q	INOX



Ref	PROFIL ISOLANT 39mm	Long
1543G		30m



Refs	RONDELLE PLATE	Dim
2698K	ZB	8 X 40
6465S	INOX	8 X 40
2931C	ZB	10 X 40
6466T	INOX	10 X 40
5278L	ZB	12 X 40



Refs	BOUCHON PVC 41 X 41	Coul
1163L		BLANC
3774S		NOIR

Refs	BOUCHON PVC 41 X 21	Coul
1164M		BLANC
5186P		NOIR



Refs	ATTACHE POUTRE	Haut
2042B		41
0364D		82
5291Y		165
5890A	INOX A2	41



Refs	ATTACHE POUTRE 41 & 21	Coul
0852M		

## 138 ACCESSOIRES 41



Ref PLAQUE 4 TROUS  
2783Y



Ref PLAQUE EN T  
2784Z



Ref EQUERRE 45  
2041A



Ref FIXATION MURALE  
0918F



Ref EQUERRE 41 ARTICULEE PLATE  
5523S



Ref MANCHON DE LIAISON  
0856R



Refs PLAQUE EN L  
2785A  
6412N INOX



Ref EQUERRE 135 Ø OBTUE  
1201A



Refs EQUERRE 90 - 2 TROUS  
1236M  
7157G GAC  
3922V INOX A2



Refs EQUERRE 90 - 4 TROUS  
0881S  
3923W INOX A2



Ref PENDART 2 TROUS  
1235L



Ref EQUERRE A GOUSSET  
1171U

## 137 BOULONNERIE PROFIL 41



Refs	BOULONNERIE RAIL 41	
4001C	8 X 30	6093L 10 X 80
6364P	8 X 40	6094M 10 X 90
2787C	8 X 50	6091J 12 X 40
6088F	8 X 60	6095N 12 X 50
6089G	10 X 30	7137L 12 X 60
6365Q	10 X 40	2790F GAC 8 X 40
2789E	10 X 50	3563B INOX A4 8 X 40
6090H	10 X 60	6195W INOX A4 10 X 40



Refs	ÉCROU SANS RESSORT	
0883U	M 6	SANS RESSORT
0909W	M 8	SANS RESSORT
0357W	M 10	SANS RESSORT
1055Y	M 12	SANS RESSORT
7149Y	M 6 INOX A4	SANS RESSORT
3918R	M 8 INOX A4	SANS RESSORT
3916S	M 10 INOX A4	SANS RESSORT
5334U	M 6 GAC	SANS RESSORT
5335V	M 8 GAC	SANS RESSORT
5336W	M 10 GAC	SANS RESSORT
5337X	M 12 GAC	SANS RESSORT



Ref ÉCROU RONDELLE POUR RAIL M8  
7177C M 8



Ref	ÉCROU RAIL AUTO		Ø
4573J			M 6
4574K			M 8
4575L			M 10
0119Y			M 12

# SUPPORTAGE

## 128 PROFIL JUNIOR

1 KN = 100 Kg

- Protection : électrozingué ou galvanisé à chaud ou inox ou époxy poudre. Couleurs RAL au choix.

- 27 x 18 x 1,25



- Pour installation légères
- Pour fixation unique ou construction efficace de nappages
- Perforation rationnelle
- Pour montage des nappages horizontaux et verticaux

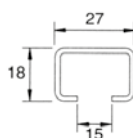

Refs.	L (mm)	S=140 N/mm <sup>2</sup>		f=1/200L	f=1/360L
		F max (kN)	f max (mm)	F (kN)	F (kN)
	500	0.714	1.85	-	-
	1000	0.352	7.39	0.235	0.129
	1500	0.231	16.70	0.099	0.051
4754W	2000	0.168	29.64	0.048	0.022
1068N	3000	<b>Note de Calcul sur demande</b>			

- 28 x 30 x 1,8



- Pour installation légères
- Pour fixation unique ou construction efficace de nappages
- Perforation rationnelle
- Pour montage des nappages horizontaux et verticaux

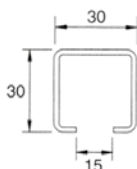

Refs.	L (mm)	S=140 N/mm <sup>2</sup>		f=1/200L	f=1/360L
		F max (kN)	f max (mm)	F (kN)	F (kN)
	500	2.615	1.11	-	-
	1000	1.297	4.44	-	0.806
	1500	0.852	9.97	0.633	0.345
4752U	2000	0.628	17.74	0.340	0.178
3655X	3000	0.396	39.85	0.123	0.051
	6000	<b>Note de Calcul sur demande</b>			

## 130 ACCESSOIRES POUR PROFIL JUNIOR



Ref APPLIQUE JUNIOR Long  
0532D 30 mm



Ref BOUCHON JUNIOR Dim  
0516M 28 X 30



Ref EQUERRE JUNIOR 90 - 2 TROUS  
1049S



Ref ATTACHE POUTRE ETRIER JUNIOR  
5502V

## 133 BOULONNERIE JUNIOR

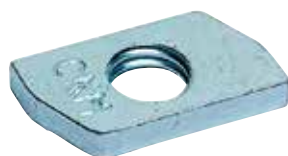

Refs ECROU POUR PROFIL JUNIOR ø  
2440R M 6  
2768H M 8



Refs BOULONNERIE JUNIOR ø  
2779U M 8 X 30  
4865M M 8 X 40

## 272 CONSOLES 41

1 KN = 100 Kg

• Protection : électrozingué ou galvanisé à chaud ou inox ou époxy poudre. Couleurs RAL au choix.

### • 41 x 21 x 2

- Pour installation légère
- Pour montage des nappages horizontaux
- Pour fixation murale de tube

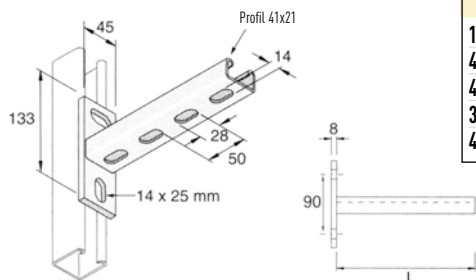

Refs.	Diagrammes de charge			
	Uniforme	F1	F1	F2
	L (mm)	1/2L	1/3L	1/4L
1074T	0.76 150	1.94 kN	0.97 kN	0.64 kN
4954C	0.86 200	1.38 kN	0.76 kN	0.48 kN
4468Z	1.03 300	1.00 kN	0.50 kN	0.33 kN
3388A	1.29 400	0.67 kN	0.33 kN	0.22 kN
4958G	1.69 600			

**Note de Calcul sur demande**

### • 41 x 41 x 2

- Pour installation semi lourde
- Pour montage des nappages horizontaux
- Pour fixation murale de tube

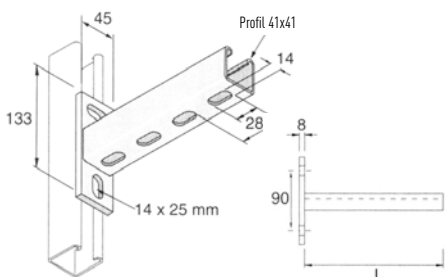

Refs.	Diagrammes de charge			
	Uniforme	F1	F1	F2
	L (mm)	1/2L	1/3L	1/4L
0715U	0.96 150	6.12 kN	3.06 kN	2.04 kN
0717W	1.30 300	3.06 kN	1.53 kN	1.02 kN
6400A	1.74 400	2.04 kN	1.02 kN	0.68 kN
1165N	1.74 450	2.04 kN	1.02 kN	0.68 kN
6401B	2.06 500	1.53 kN	0.76 kN	0.50 kN
3387Z	2.06 600	1.53 kN	0.76 kN	0.50 kN
2929A	2.30 750	1.223 kN	0.61 kN	0.40 kN
4163U	2.99 1000			
6402C	2.99 1200			

**Note de Calcul sur demande**

### • 41 x 83 x 2,5

- Pour installation lourde
- Perforation de 11 x 25 mm tous les 50 mm

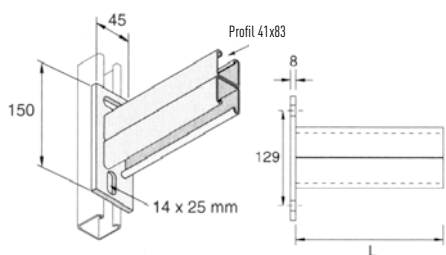

Refs.	Diagrammes de charge			
	Uniforme	F1	F1	F2
	L (mm)	1/2L	1/3L	1/4L
	1.57 150	8.82 kN	4.41 kN	2.94 kN
	3.26 300	6.47 kN	3.23 kN	2.15 kN
	4.02 450	4.31 kN	2.15 kN	1.43 kN
4697N	4.98 600	3.23 kN	1.61 kN	1.07 kN
4441W	5.83 750	2.58 kN	1.29 kN	0.86 kN
4442Y	1000			

**Note de Calcul sur demande**

## SUPPORTAGE GALVANISÉ A CHAUD

6413P	APPLIQUE RAIL 41	VERTICALE	GAC	P6	
2790F	BOULONNERIE 41	8X 40	GAC	P7	
0120Z	CONSOLE SIMPLE	41 X 41 X 244	GAC	P9	
0121A	CONSOLE SIMPLE	41 X 41 X 344	GAC	P9	
0123C	CONSOLE SIMPLE	41 X 41 X 444	GAC	P9	
0124D	CONSOLE SIMPLE	41 X 41 X 544	GAC	P9	
0125E	CONSOLE SIMPLE	41 X 41 X 644	GAC	P9	
7157G	EQUERRE 90°	2 TROUS	GAC	P7	
0432Z	PROFIL SIMPLE	41X41X2.5	6ML	GAC	P5
5408W	PROFIL SIMPLE	41X21X2	3ML	GAC	P5
5409X	PROFIL SIMPLE	41X41X2	3ML	GAC	P5

## SUPPORTAGE INOX

5890A	ATTACHE POUTRE 41	INOX A2	P6
3563B	BOULONNERIE 41 8 X 40	INOX A4	p7
6195W	BOULONNERIE 41 10 X 40	INOX A4	p7
3560Y	CONSOLE 41 X 41 X 300	INOX	p9
3561Z	CONSOLE 41 X 41 X 450	INOX	p9
3562A	CONSOLE 41 X 41 X 600	INOX	p9
6336T	CONSOLE 41 X 41 X 750	INOX	p9
6325G	CONSOLE 41 X 41 X 1000	INOX	p9
7149Y	ECROU M 6 SANS RESSORT	INOX A4	p7
3918R	ECROU M 8 SANS RESSORT	INOX A4	p7
3919S	ECROU M10 SANS RESSORT	INOX A4	p7
5889Z	EMBASE LOURDE 41X41	INOX A2	p6
3922V	EQUERRE 90° 2 TROUS	INOX A2	p7
3923W	EQUERRE 90° 4 TROUS	INOX A2	p7
6412N	PLAQUE EN L	INOX	p7
6465S	RONDELLE PLATE 8X40X3	INOX	p6
6466T	RONDELLE PLATE 10X40X3	INOX	p6



# SUPPORTAGE

## 145 COLLIER ISO LOURD M8 / M10

Données techniques :

- Matériau : SPCC-SD FB - Q/BQB402, DC01 - EN 10130
- Finition de surface : électro-zingué
- Résistance aux températures -40°C à 110°C
- Atténuation phonique : 16dB(A)

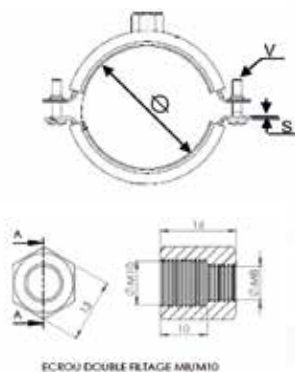

ÉLECTRO-ZINGUÉ		
Refs.	d (mm)	Ø "
1077W	12 - 15	1/4"
1061E	15 - 19	3/8"
1062F	20 - 24	1/2"
1063G	23 - 28	3/4"
1064H	31 - 36	1"
1065J	38 - 44	1 1/4"
1066K	44 - 50	1 1/2"
1067L	54 - 58	
1069N	59 - 65	2"
1071Q	66 - 72	
1072R	74 - 80	2 1/2"
1073S	81 - 86	
6403D	87 - 93	3"
1075U	99 - 104	
1076V	108 - 115	4"
2133N	121 - 127	
6019J	133 - 142	5"
2132V	148 - 152	
2135Y	159 - 165	
5153E	165 - 171	
2136Z	179 - 184	
3417F	198 - 202	
2137A	216 - 220	
5735N	248 - 252	
5736P	313 - 317	

INOX		
Refs.	d (mm)	Ø "
3642J	20 - 24	
3643K	26 - 30	
3648Q	32 - 36	
3644L	38 - 42	
3645M	47 - 50	1 1/2"
6380F	52 - 56	
3649R	60 - 64	
3650S	75 - 80	2 1/2"
3646N	87 - 92	3"
6122S	99 - 105	
7103A	106 - 112	
3647P	114 - 119	
6329L	124 - 131	
7104B	133 - 140	
6330M	159 - 163	

## 148 COLLIER NU LOURD SANS ISO M8 / M10



Refs.	d (mm)	Ø "	A x B (mm)	Cuivre Chauffagiste
1086F	15-18	3/8"	20 x 2.00	5/8
1087G	20-24	1/2"	20 x 2.00	7/8
1088H	24-28	3/4"	20 x 2.00	1" 1/8
1089J	32-36	1"	20 x 2.00	1" 3/8
1090K	38-44	1 1/4"	20 x 2.00	1" 5/8
1091L	44-53	1 1/2"	20 x 2.00	
1376H	50-56		20 x 2.00	
1612D	56-65	2"	20 x 2.00	2" 1/8
5737Q	60-66		20 x 2.00	
5738R	65-71		20 x 2.00	
1613E	72-78		20 x 2.00	
0517N	76-84	2 1/2"	20 x 2.00	3" 1/8
0518P	87-92	3"	20 x 2.00	3" 5/8
0525N	99-106		20 x 2.00	
0522T	107-115	4"	20 x 2.00	
1606X	124-129		20 x 2.00	
1608Z	135-142	5"	20 x 2.00	
5740T	155-159		20 x 2.00	
3974Z	158-165		20 x 2.00	
3973Y	165-171	6"	20 x 2.50	
5151C	179-185		20 x 2.50	
5741U	184-195			
1176Z	198-202		20 x 2.50	
5742V	210-215			
0906T	215-220		20 x 2.50	
6050S	225-240			
5743W	248-252			
5744X	270-280			
5745Y	313-329			

## 148 COLLIER NU UNI LOURD SOLID N



COLLIER NU INOX		
Refs.	d (mm)	Ø "
7106D	36 - 42	
7107E	47 - 50	
7108F	60 - 64	
7109G	75 - 80	
7110H	87 - 92	
7111J	106 - 112	
7112K	124 - 131	
7113L	159 - 163	5"

Refs.	d (mm)	Ø "	Refs.	d (mm)	Ø "
6807T	15-19	M8/M10	6828P	159-165	M12/M16
6808T	20-24	M8/M10	6829Q	167-173	M12/M16
6809U	25-30	M8/M10	6830R	176-182	M12/M16
6810V	31-35	M8/M10	6831S	188-194	M12/M16
6811W	36-41	M8/M10	6832T	199-205	M12/M16
6812X	40-45	M8/M10	6833U	207-216	M12/M16
6813Y	48-53	M8/M10	6834V	219-226	M12/M16
6814Z	54-59	M8/M10	6835W	227-236	M12/M16
6815A	60-65	M8/M10	6836X	244-250	M12/M16
6816B	67-72	M8/M10	6837Y	251-261	M12/M16
6817C	76-81	M10/M12	6838Z	267-273	M12/M16
6818D	82-85	M10/M12	6839A	278-284	M12/M16
6819E	88-94	M10/M12	6840B	297-304	M12/M16
6820F	95-102	M10/M12	6841C	305-316	M12/M16
6821G	102-108	M10/M12	6842D	320-328	M16
6822H	110-116	M10/M12	6843E	352-360	M16
6823J	117-124	M10/M12	6844F	364-372	M16
6824K	124-129	M10/M12	6845G	402-410	M16
6825L	133-140	M12/M16	6846H	415-423	M16
6826M	140-146	M12/M16	6847J	504-512	M16
6827N	149-155	M12/M16	6848K	517-525	M16



## 154 COQUILLE FROID BI-MATIÈRE

- Support isolant de tuyauterie
- Noyau PIR densité 80 kg / m<sup>3</sup>



19 Refs.	Ep (mm)	ø Int (mm)	ø Ext (mm)
6404E	19	10	48
6405F	19	12	50
3809D	19	15	53
5193W	19	19	56
5710M	19	20	59
5194X	19	22	60
5711N	19	25	65
5195Y	19	28	66
5712P	19	32	71
5196Z	19	35	73
5197A	19	42	80
5198B	19	48	86
6971N	19	50	88
5199C	19	54	93
5200D	19	60	98
5201E	19	64	104
5202F	19	70	110
5203G	19	76	116
5204H	19	80	119
5205J	19	89	129
5206K	19	102	142
5207L	19	114	152
5208M	19	140	182
5695W	19	168	208
6972P	19	219	257

25 Refs.	Ep (mm)	ø Int (mm)	ø Ext (mm)
6685N	25	10	60
6686P	25	15	65
6687Q	25	19	69
6688R	25	20	70
6689S	25	22	72
6690T	25	25	75
6691U	25	28	78
6692V	25	32	82
6693W	25	35	85
6694X	25	40	90
6695Y	25	42	92
6696Z	25	48	98
6697A	25	50	100
6698B	25	54	104
6699C	25	60	110
6700D	25	64	114
6701E	25	67	117

25 Refs.	Ep (mm)	ø Int (mm)	ø Ext (mm)
6702F	25	70	120
6703G	25	76	126
6704H	25	80	130
6705J	25	89	139
6706K	25	92	142
6707L	25	108	158
6708M	25	114	164
6709N	25	125	175
6710P	25	133	183
6711Q	25	140	190
6712R	25	160	210
6713S	25	168	218
6714T	25	219	269
6715U	25	273	323
6716V	25	324	374
6717W	25	356	406
6718X	25	406	456

32 Refs.	Ep (mm)	ø Int (mm)	ø Ext (mm)
6406G	32	10	74
6407H	32	12	76
6408J	32	15	79
2999U	32	19	82
5209N	32	22	86
6973Q	32	25	89
5210P	32	28	92
5211Q	32	35	99
5212R	32	42	106
5213S	32	48	112
5214T	32	54	118
5215U	32	60	124
5216V	32	64	130
5217W	32	70	136
5218X	32	76	142
5219Y	32	80	146
5220Z	32	89	155
5221A	32	102	168
5222B	32	114	182
5223C	32	140	208

40 Refs.	Ep (mm)	ø Int (mm)	ø Ext (mm)
6974R	40	42	122
6975S	40	48	128
6976T	40	54	134
6977U	40	60	140
6978V	40	64	144
6979W	40	76	156
6980X	40	89	169
6981Y	40	140	220

DONNÉES TECHNIQUES	
Domaine d'application	Support isolant monobloc composé de deux éléments PIR (sans CFC) avec une mousse de base de caoutchouc synthétique.
Domaine d'application	Éviter les ponts thermiques en réfrigération et air conditionné
Partie centrale en PIR sans CFC Résistance à la pression suivant DIN EN 826	620 kPa
Température d'utilisation	de - 50 °C à + 150 °C
Temps de stockage	H. R. entre 50 et 70% température entre 10 °C et 35 °C. 1 an.
Comportement en cas d'incendie	Euroclasse E
Tolérance sur l'épaisseur	± 1,5 mm

## 154 COQUILLE FROID POLYURÉTHANE

30 Refs.	Ep (mm)	ø Int (mm)	ø Ext (mm)
6024P	30	18	78
5713Q	30	22	82
5714R	30	28	88
5715S	30	35	95
5716T	30	42	102
5717U	30	48	108
5718V	30	54	114
5719W	30	60	120
5720X	30	76	136
5721Y	30	89	149
6022M	30	108	168
5722Z	30	114	174
5723A	30	140	200

40 Refs.	Ep (mm)	ø Int (mm)	ø Ext (mm)
5724B	40	22	102
5725C	40	28	108
5726D	40	35	115
5727E	40	42	122
5728F	40	48	128
6025Q	40	54	134
5729G	40	60	140
5730H	40	76	156
5731J	40	89	169
6026R	40	102	182
3060V	40	108	188
5732K	40	114	194
5733L	40	140	220
6987E	40	160	240
5734M	40	168	248
6988F	40	219	299

50 Refs.	Ep (mm)	ø Int (mm)	ø Ext (mm)
6030V	50	18	118
6031W	50	22	122
6032X	50	35	135
6033Y	50	42	142
6034Z	50	48	148
6035A	50	54	154
6042H	50	60	160
6036B	50	76	176
6037C	50	89	189
6038D	50	108	208
6039E	50	114	214
6040F	50	140	240
6041G	50	168	268
6989G	50	219	319

- 33 kg M1 + Revalu 18
- Longueur coquille 1 ml
- Classement au feu M1



**MANCHON ISOLANT**  
DISPONIBLE SUR CONSULTATION  
CHEZ POINTFIX



# SUPPORTAGE

## 151 COLLIER GAINÉ VENTILATION ISO



Refs	∅	Refs	∅
1530T	100	0181N	400
1533W	125	0182P	450
1534X	160	0183Q	500
1536Z	200	1523L	560
1537A	250	0184R	630
1539C	315	1520H	710
0180M	355		

## 158 COLLIER EAUX PLUVIALES M8-M7



Refs	∅	Refs	∅
6117M	M7 100	0358X	M8 100
6118N	M7 125	0958X	M8 110
		0359Y	M8 125

## 147 COLLIER PLOMBIER ISO SIMPLE



Refs	∅	Refs	∅
2666B	12	2350X	26
2667C	14	2070F	28
2668D	16	2072H	32
2669E	18	0520R	40
2670F	20	2069E	42
2671G	22	5171X	50
2348V	24		

## 147 COLLIER PLOMBIER ISO DOUBLE



Refs	∅	Refs	∅
2068D	COLLIER DOUBLE ISO 8-10	2675L	COLLIER DOUBLE ISO 16-18
2672H	COLLIER DOUBLE ISO 10-12	2676M	COLLIER DOUBLE ISO 18-20
2673J	COLLIER DOUBLE ISO 1 12-14	2677N	COLLIER DOUBLE ISO 20-22
2674K	COLLIER DOUBLE ISO 14-16	3824U	COLLIER DOUBLE ISO 26-28

## 150 COLLIER PLOMBIER SANS ISO SIMPLE



Refs	∅	Refs	∅
0964D	8	6027S	26
0965E	10	0974P	28
0966F	12	0975Q	30
0967G	14	0976R	32
0968H	16	0980V	40
0969J	18	0981W	42
0970K	20	0984Z	50
0971L	22	0985A	60
0972M	24	2299U	63
6318Z	25		

## 150 COLLIER PLOMBIER SANS ISO DOUBLE



Refs	∅
0986B	8-10
0987C	10-12
0988D	12-14
0989E	14-16
0990F	16-18
0991G	18-20
0922H	20-22
3823T	26-28

## 200 CHEVILLE MATERIAUX CREUX

### CHEVILLE MÉCANIQUE À EXPANSION

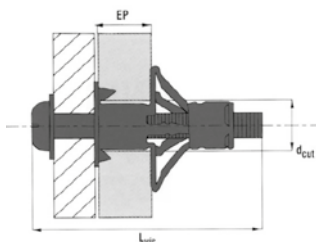

modèle **SV** - Cheville mécanique sans vis



modèle **AV** - Cheville mécanique avec vis



Ø	Refs. AV	Refs. SV	L mm	EP mm	d <sub>cut</sub> mm	L <sub>vis</sub> mm
M4	0013N	0009J	33	3-14	8	41
	3274G	-	47	16-26	8	54
M5	0014P	0010K	37	6-12	10	45
	1830F	1836M	53	3-16	10	60
M6	2317N	0011L	66	16-32	10	71
	0015Q	0012M	37	6-12	12	45
	1832H	1838P	53	3-16	12	60
M8	1258K	1192R	66	16-32	12	71
	0002B	4976A	55	3-16	13	65
	3412A	-	68	16-32	13	75

## 248 PATTE A VIS MONTEE



Refs	Dim
4002D	5 X 37
4090T	5 X 50
2002K	6 X 37
6145U	6 X 50

### PINCE PRO CHEVILLE PLACO



Refs	Dim
0021W	M 4 - M 6
4637A	M 4 - M 8

## 248 ACCESSOIRES POUR COLLIER



Refs	Dim
1002T	5 X 45
1003U	5 X 50
2067C	5 X 60
2066B	5 X 70
0430X	6 X 45
1004V	6 X 50
4822S	6 X 70

### PATTE A VIS BOIS



Refs	Dim
2826T	6 X 40
2531L	7 X 30
2532M	7 X 40
2533N	7 X 50
2534P	7 X 60
2054P	7 X 70
2230X	7 X 80
2767G	8 X 40
5182K	8 X 50

### PATTE A VIS BOIS SANS COLLERETTE



Refs	Dim
1052V	8 X 50
4959H	8 X 60
2535Q	8 X 80

### VIS DOUBLE FILET ZB



Refs	Dim
5424N	8 X 60
1489A	8 X 80
5425P	8 X 90
5427R	8 X 120
1492D	10 X 120
1493E	10 X 140

### PATTE A VIS BOIS FEMELLE



Refs	Dim
6065F	M 6
6066G	M 7
6067H	M 8

### COLLIER TWIST TIGE FILETEE



Refs	Ø	
1877E	32	SACHET DE 10
4607U	40	SACHET DE 10
5804L	50	SACHET DE 10



Refs	Taille	
4946V	TAILLE 3/8—5/8	SAC DE 5

### ROSACE CONIQUE



Refs	Ø
0993J	9 28
0994L	14 32
0995L	19 38
0996M	24 42
3296E	30 45

### ROSACE PLATE



Refs	Ø
2200R	25
2063Y	30

# SUPPORTAGE

## 280 ETRIERS ZINGUES



Refs	Ø		
0197E	13 X 6	1/4"	2ECR
0198F	17 X 6	3/8"	2ECR
0199G	21 X 6	1/2"	2ECR
0200H	27 X 8	3/4"	2ECR
0201J	34 X 8	1"	2ECR
0202K	42 X 8	1 1/4"	2ECR
0203L	49 X 8	1 1/2"	2ECR
0204N	60 X 8	2"	2ECR
0206P	76 X 10	2 1/2"	2ECR
0207Q	89 X 10	3"	2ECR
0208R	102 X 12	3 1/2"	2ECR
1283L	108 X 12		2ECR
0209S	114 X 12	4"	2ECR
1289S	133 X 12	4 3/4"	2ECR
0210T	139 X 12	5"	2ECR
0211U	168 X 14	6"	2ECR

## 280 ETRIERS RALLONGE ZINGUES



Refs	Ø		
5060P	21	1/2"	M 8
5061Q	27	3/4"	M 8
5062Q	34	1"	M 8
5063S	42	1 1/4"	M10
5064T	48	1 1/2"	M10
5065U	60	2"	M10
5066V	76	2 1/2"	M10
5067W	89	3"	M10
5068X	114	4"	M12
5069Y	139	5"	M12
5070Z	168	6"	M12
5293A	219	8"	M12
5294B	273	10"	M16
5295C	323	12"	M16

## 280 ETRIERS A2 INOX



Refs	Ø		
2379C	14 X 6	1/4"	2ECR
2380D	18 X 6	3/8"	2ECR
2381E	22 X 6	1/2"	2ECR
2382F	27 X 8	3/4"	2ECR
2383G	34 X 8	1"	2ECR
2384H	43 X 8	1 1/4"	2ECR
2385J	49 X 8	1 1/2"	2ECR
2386K	61 X 8	2"	2ECR
2387L	71 X 8	2 1/4"	2ECR
2388M	77 X 8	2 1/2"	2ECR
2389N	89 X 8	3"	2ECR
4102F	102 X 12	3 1/2"	2ECR
4103G	115 X 10	4"	2ECR
4104H	140 X 10	5"	2ECR
7138M	168 X 12	6"	2ECR

## 028 TIRANT ZN POUR BRIDE 3 ECROUS



Refs	Ø
5865Z	16 X 110
5866A	16 X 120
5867B	16 X 130
5868C	16 X 140
5869D	20 X 150
5870E	20 X 160
5871F	20 X 180
5872G	20 X 200

## 178 FEUILLARD - 25ML

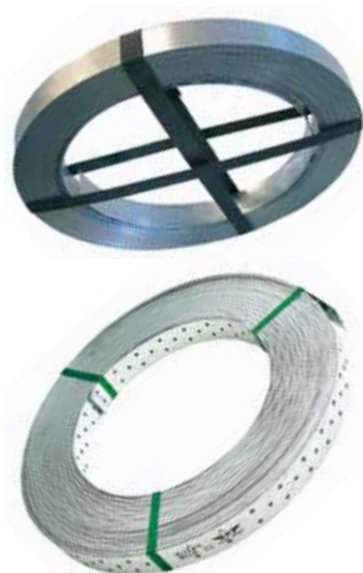

### FEUILLARD NON PERFORE

Refs	Dim	Long
4096Z	20X0,8 mm	25 ML
6115J	17 mm	25 ML

### FEUILLARD PERFORE

Refs	Dim	Long
0450T	12 mm	10 ML
1026T	17 mm	25 ML
5671W	20 mm	25 ML
2149N	25 mm	25 ML

## 153 COLLIER POIRE ZN M10 - M12



- Installation sûre en une pièce
- A installer au bout de tiges filetées
- Protection électrozinguée
- Agrément FM / UL

Refs.	d (mm)	d (mm) Extérieur	Ø" Nominal	A x B (mm)	M
1451L	22	15	1/2"	22 x 1	M10
1462X	28	20	3/4"	22 x 1	M10
1464Z	35	25	1"	22 x 1	M10
1468D	40	32	1 1/4"	22 x 1,2	M10
1469E	48	40	1 1/2"	22 x 1,2	M10
1471G	60	50	2"	22 x 1,2	M10
1472H	76	65	2 1/2"	22 x 1,2	M10
1483U	90	80	3"	22 x 1,2	M10
1499L	115	100	4"	22 x 2	M10
1444D	140	125	5"	32 x 2	M12
1457S	160	150	6"	32 x 2	M12
5059N	220	200	8"	40 x 2	M12



## 210 FIXATION SANITAIRE

### FIXE CHAUFFE-EAU



Refs	Dim
2140D	10 X 120 PL
2142F	10 X 140 CR
0940D	10 X 140 TH

### FIXATION LAVABO PLEIN



Refs	Dim
0026B	8 X 90 PL

### FIXATION LAVABO CREUX

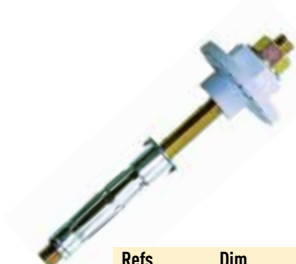

Refs	Dim
3639F	8 X 12 / 37
3640G	8 X 16 / 55

### FIXATION LAVABO CREUX



Refs	Dim
0705J	8 X 110
6125U	10 X 140

### FIXATION WC BIDET



Refs	Dim
0546T	6 X 70 CHROM

### FIXATION WC BIDET



Refs	Dim
3873V	8 X 80 CR / BL

### FILETFIX III - RÉSINE ANAÉROBIE

Produit d'étanchéité pour raccords filetés en contact des gaz combustibles (gaz naturel, butane, propane), de l'eau froide, de l'eau chaude, de l'air et des produits pétroliers.

- Conforme aux Listes Positives (CLP) pour la mise en contact avec l'eau destinée à la consommation humaine.
- Conforme à la norme européenne EN 751-1 Classe H /Agrément DVGW\*, matériaux d'étanchéité pour raccords filetés au contact des gaz (gaz naturel, butane, propane) et de l'eau chaude.
- Certifié par CERTIGAZ NF RAC-GAZ (NF 540), matériaux d'étanchéité pour raccords filetés des installations de gaz.
- Agrément eau potable WRAS.

Refs  
4753V



## 180 ATTACHE ET CROCHETS

### ATTACHE MULTICLIP PLUS SIMPLE



Refs	Ø
4746N	16
4748Q	20
6479G	25
4817M	32

### ATTACHE MULTICLIP PLUS DOUBLE



Refs	Ø
4747P	20
6480H	25

### ATTACHE MULTICLIP DOUBLE BLANC



Refs	Ø
1013E	M6 16-18 mm
1014F	M6 20-22 mm

# SUPPORTAGE

## 141 ACCESSOIRES POUR CHEMIN DE CABLE



Refs	CONSOLE UNIVERSELLE L	Long
6939E		500
6938D		400
6937C		300
6936B		200
6935A		150
6934Z		100



Refs	CONSOLE UNIVERSELLE C	Long
6933Y		500
6932X		400
6931W		300
6930V		200
6929U		150
6928T		100

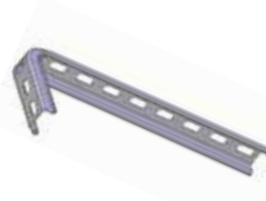

Refs	PENDARD MONTAGE DOUBLE POUR CONSOLE UNIVERSEL OBP	Long
6946M		250
6947N		450
6948P		550
6949Q		650

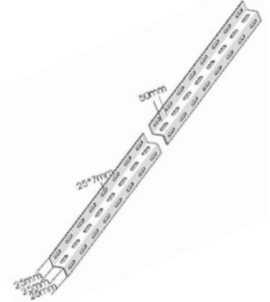

Refs	ZED PERFO	
4082K	24 X 24 X 24 X 2	EZ
4083L	48 X 48 X 48 X 2	EZ



Refs	CONSOLE ENCLIQUETABLE EDF	Long
4632V		100
4633W		150
4634X		200
4635Y		300



Refs	PENDART EDF PERFO. 3 FACES	Long
3634A		1000
4636Z		600
0466K		800



Refs	COUDE 90 °	Long
4069W		99
4070X		147
4071Y		195
4072Z		316

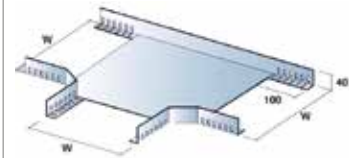

Refs	JONCTION EN T	Long
3997Y		99
3998Z		147
3999A		195
4000B		316



Refs	SUSPENSION OMEGA UNIVER.	Long
7130D	PROFIL UNIVER. POUR CHEMIN CABLE	2000
2392R		200
2519Y		300
2545A		400
2563U		600



Ref	SUSPENSION CENTR. CLICK	ø
6952T		M 8

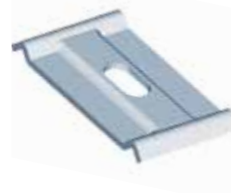

Ref	SUSPENSION CENTRALE 9
0696Z	



Refs	CROCHET BALANCELLE POUR CDC FIL
3804Y	



Ref	SUPPORT MURAL POUR FIL 60 X 60
2308D	



Ref	SUPPORT BOÎTE DE DÉRIVATION
0018T	



Ref	ECLISSE RENFORCÉ FIL À VISSER
0003C	



Refs	COUVERCLE CHEMIN DE CABLE	Long
6530K	CLIP COUVERCLE CHEMIN DE CABLE FIL	
6527G	COUVERCLE CHEMIN DE CABLE FIL	100
6528H	COUVERCLE CHEMIN DE CABLE FIL	150
6529J	COUVERCLE CHEMIN DE CABLE FIL	200
6536R	COUVERCLE CHEMIN DE CABLE FIL	300
6578J	CLIP COUVERCLE CHEMIN DE CABLE TOLE	
6571B	COUVERCLE CHEMIN DE CABLE TOLE	50
6572C	COUVERCLE CHEMIN DE CABLE TOLE	100
6573D	COUVERCLE CHEMIN DE CABLE TOLE	150
6574E	COUVERCLE CHEMIN DE CABLE TOLE	200
6575F	COUVERCLE CHEMIN DE CABLE TOLE	300
6576G	COUVERCLE CHEMIN DE CABLE TOLE	400
6577H	COUVERCLE CHEMIN DE CABLE TOLE	500

EXISTE  
EN VERSION  
INOX ET GAC



Refs	PONTET OMEGA	Long
7181G		99
7182H		147
7183J		195
7184K		316
7185L		412



Ref	CLIPS CKBT POUR FIL BKT
0027C	



Ref	CLOISON SÉPARATION CHEMIN DE CABLE
6567X	H : 48 mm



## 139 CHEMIN DE CABLE FIL AUTO

- Protection : électrozingué, galvanisé à chaud, inox ou époxy poudre. Couleurs RAL au choix.
- Chemin de câbles en fil soudé avec un bord de sécurité pour l'installation
- Léger et offre une aération maximale
- Souplesse, élasticité et grande résistance



EXISTE  
EN VERSION  
INOX ET GAC

- Canalisation, transport et distribution des câbles électriques et de télécommunications dans les installations civiles, de tunnels, de bâtiments publics, de centre commerciaux, de grandes infrastructures, d'aéroports, de lignes de métro, train, etc
- Installations dans le secteur tertiaire et industriel. Applications dans l'industrie navale, le pétrochimie, le textile et l'agro-alimentaire.
- Spécialement approprié aux installations photovoltaïques, éoliennes, dans l'industrie énergétique et les énergies renouvelables.

Refs.	Dim (mm)
6120Q	54 X 50
4011N	54 X 100
5240V	54 X 150
4009L	54 X 200
5232M	54 X 300
5230K	54 X 400
6474B	54 X 500

## 140 CHEMIN DE CABLE TOLE

- Protection : électrozingué, galvanisé à chaud, inox ou époxy poudre. Couleurs RAL au choix.
- Le fond de la dalle est embouti et perforé, certifié selon les marquages : N de Aénor et E90 DIN-4102-12
- Protection des extrémités facilitant le transport



EXISTE  
EN VERSION  
INOX ET GAC

Refs.	Dim (mm)
6566W	48 x 51
6537S	48 x 99
6538T	48 x 147
6539U	48 x 195
6540V	48 x 316
6541W	48 x 412
6542X	48 x 508

## 141 ACCESSOIRES POUR CHEMIN DE CABLE



Ref BORNE DE TERRE  
1766P 25 mm<sup>2</sup>



Ref GRIFFE DE TERRE  
1725W ALU 35 mm<sup>2</sup>



**CHEMIN DE CABLE PLASTIQUE**  
DISPONIBLE SUR CONSULTATION  
CHEZ POINTFIX

# SUPPORTAGE

## 167 CLIPS ET PINCE D'ANCRAGE



Refs	CLIPS	Ø
1922B	CLIPS 1-4	6 - 7
1951G	CLIPS 1-4	8 - 9
1979L	CLIPS 1-4	10 - 11
1980M	CLIPS 1-4	12 - 14
2516V	CLIPS 1-4	15 - 18
2626X	CLIPS 1-4	19 - 24
2634T	CLIPS 1-4	25 - 30

Refs	CLIPS	Ø
1874B	CLIPS 4-7.5	6 - 7
1032Z	CLIPS 4-7.5	8 - 9
1921A	CLIPS 4-7.5	10 - 11
1033A	CLIPS 4-7.5	12 - 14
1034B	CLIPS 4-7.5	15 - 18
2981E	CLIPS 4-7.5	19 - 24
1041J	CLIPS 4-7.5	25 - 30

Refs	CLIPS	Ø
4808C	CLIPS 7.5-12	6 - 7
1037E	CLIPS 7.5-12	8 - 9
4809D	CLIPS 7.5-12	10 - 11
1038F	CLIPS 7.5-12	12 - 14
1042K	CLIPS 7.5-12	15 - 18
1204D	CLIPS 7.5-12	19 - 24
1043L	CLIPS 7.5-12	25 - 30



Ref CLIPS PANNE Z  
1821W



Refs	CLIPS M	Ø
1816R	6l	1.5 - 4
1015G	6l	4 - 10
1016H	6l	10 - 15
2486P	6l	15 - 20
1819U	8l	1.5 - 4
2520Z	8l	4 - 10
2521A	8l	10 - 15
2546B	8l	15 - 20



Refs	CLIPS I	Ø
1005W	1.5 - 4	
1006X	4 - 10	
1007Y	10 - 15	
4730W	15 - 20	



Refs	PINCE ANCRAGE FLS	Ø
4098B		M 8
4050B		M 10



Refs	PINCE ANCRAGE	Ø
2171L		TROU 9
1965W		TROU 11
2035U		TROU 13
4744L		TROU 17
OUVERT. 28mm		

### Refs PATTE DE SERRAGE VERTICALE

4003E	170 mm	138 mm UTILE
4506P	220 mm	188 mm UTILE



### Refs PATTE DE SERRAGE HORIZONTALE

4004F	170 mm	110 mm UTILE
4507Q	220 mm	160 mm UTILE



## 171 SILENT BLOC



### Refs SILENT BLOC MÂLE / MÂLE

4628R	MM06	20 X 15
0711Q	MM08	30 X 15
5298F	MM08	30 X 30
5299G	MM08	40 X 40
2034T	MM10	40 X 35



### Refs SILENT BLOC MÂLE / FEMELLE

2770K	MF 08	30 X 30
2771L	MF 10	40 X 35



### Refs SILENT BLOC APK

5300H	40 - 160 KG
5301J	80 - 260 KG
2812D	135 - 500 KG



### Ref PATTE EQUERRE SUSPENSION

3353P



### Ref CAOUTCHOUC EPDM

3352N + rondelle P/PATT



### Ref SILENT BLOC CONIQUE

4851X KIT 4 SILENT BLOCS + ECR +RDL M08 30 X 15

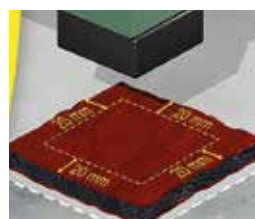
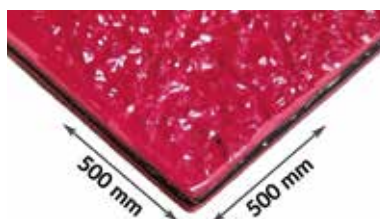

### Ref PLAQUE ANTI-VIBRATOIRE GRIPSOL

4967R	11mm	3 Kg/cm <sup>2</sup>
4968S	15mm	5 Kg/cm <sup>2</sup>

## 247 SUPPORTS



Refs	SUPPORT TERRASSE ECO	Dim
6284P	LA PAIRE ANCREE 21mm	250x130x50
6315W	LA PAIRE ANCREE 21mm	400x130x95
6316X	LA PAIRE ANCREE 21mm	600x130x95
6382H	LA PAIRE ANCREE 21mm	1000x130x95

Refs	SUPPORT TERRASSE	Dim
5148Z	LA PAIRE maxi 50 KG	250X130X50
5554Y	LA PAIRE maxi 100Kg	250x180x95
5555A	LA PAIRE maxi 200Kg	400x180x95
5556B	LA PAIRE maxi 100Kg	400X130X50
5557C	LA PAIRE maxi 120Kg	500X130X50
3322G	LA PAIRE maxi 300Kg	600x180x95
3935J	LA PAIRE maxi 500Kg	1000x180x95



Ref	PIED DE TERRASSE
4940P	TELESCOPIQUE DEMONTABLE



Ref	PLAQUE ANTI-VIBRATILE
5326L	330 X 330 X 45mm CHARGE MAX 250 Kg



Ref	PLAT DE MONTAGE	Long
0128H		2 ml



Ref	CAISSE ASSORTIMENT
0130K	POUR PLAT DE MONTAGE

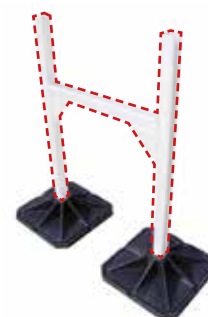

Ref	PIEDS POUR SUPPORT DE GAINES
6498B	SUPPORT DE GAINES EN H

## 274 SUPPORTS DE GROUPE ET ACCESSOIRES

### SUPPORT CLIM

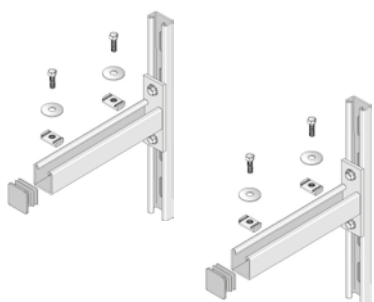

Refs	SUPPORT CLIM	Dim
1056Z	GALVA	41-450
2138B	GALVA	41-600



Refs	SUPPORT PLIANT CLIM	POIDS MAXI
6802N	420MM 420X400X780 mm	100 KG
6803P	450MM 450X400X800 mm	160 KG
6804Q	600MM 600X400X1000 mm	280 KG

Ref	SUPPORT PLIANT CLIM	POIDS MAXI
7155E	INOX 450mm 450 X 380 X 800 mm	150 KG

# FIXATION

## 186 GOUJON D'ANCRAGE

- Filetage long, écrou et rondelle montés.
- Douilles en 3 éléments garantissant une expansion équilibrée et bien répartie.
- Acier haute résistance pour des performances importantes.
- Extrémité avec chanfrein protégeant le filetage lors de la pose.



Charges indicatives de tenue en traction en Kg

**SUR BÉTON**

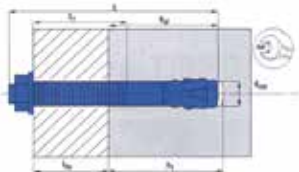
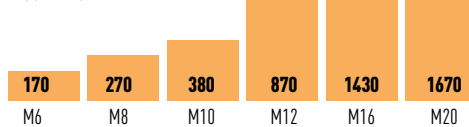

Ø	Refs.	ZINGUÉ		
		L	tfix	dcut
		mm	mm	mm
M6	4678T	55	15	6
	2174P	85	45	6
M8	5157H	60	5	8
	4484R	75	20	8
	5359V	80	30	8
	4485S	95	40	8
	6308P	115	60	8
	4486T	135	80	8
	1823Y	155	110	8
M10	6735Q	165	115	8
	6310R	65	5	10
	4487U	85	5/25	10
	4488V	95	35	10
	4894S	135	55/75	10
M12	6560Q	155	75/95	10
	6311S	85	5	12
	4489W	105	25/45	12
	6312T	125	25/45	12
	4490X	135	55	12
	6783T	165	65/85	12
M16	5159K	180	100	12
	6314V	105	5	16
	4491Y	145	25/45	16
	4492Z	180	80	16
M20	6313U	200	100	16
	0925N	160	45	20
	0926P	215	100	20

Refs.	INOX		
	L	tfix	dcut
	mm	mm	mm
1296Z	65	10	6
1304H	95	40	8
2179U	115	60	8
3010F	135	55/75	10
3011G	145	45/65	12
3012H	145	25/45	16
3863K	75	20	8
3864L	95	15/35	10
3865M	105	5/25	12
3866N	115	15	16
3867P	125	25/45	12

**L** Longueur  
**tfix** Epaisseur maxi pièce à fixer  
**dcut** Diamètre perçage

## 185 CHEVILLE FEMELLE FIC

### OUTIL DE POSE FIC

- Expansion contrôlée par outil de pose (STSR)

Refs	Ø
0857S	6
0858T	8
0859U	10
0860V	12
0861W	16



### CHEVILLE FEMELLE CONE FIC

- Acier zingué (SAPLUS).
- Matériaux béton et béton fissuré.
- Long filetage intérieur.
- Avec ou sans colerette.



Ø	Refs.	L	dcut	h1	emin
		mm	mm	mm	mm
M6	2184Z	55	5	6	50
M8	2185A	85	30	6	75
M10	2186B	50	2	8	55
M12	2187C	70	20	8	55
M16	2188D	95	45	8	55

## 183 CHEVILLE LAITON



Refs.	Type
0903Q	M 5 X 20
0904R	M 6 X 24
0265A	M 7 X 150
0905S	M 8 X 30

## 188 CHEVILLE UNIVERSELLE CHARGE LOURDE

- Cheville tous matériaux à expansion maximum.
- Principales applications : portes industrielles, rayonnages.
- Offre une alternative au scellement chimique dans la maçonnerie creuse pour une fixation instantanée.
- 4 jambes d'expansion assurant un ancrage parfait dans tous les matériaux.



Matériaux



Ø	Refs.	Ø cheville mm	L mm
<b>VERSION SANS VIS</b>			
M6	4686B	12	50
M8	4687C	14	55
<b>VERSION AVEC VIS CLASSE 8.8 ET RONDELLES PRÉMONTÉES</b>			
M8	4975Z	14	60
M8	4502K	14	75
M10	6645W	16	75
M10	4503L	16	90
M12	6646X	20	90
M12	6647Y	20	110

## 200 CHEVILLE MATERIAUX CREUX

### CHEVILLE AUTOPERCEUSE

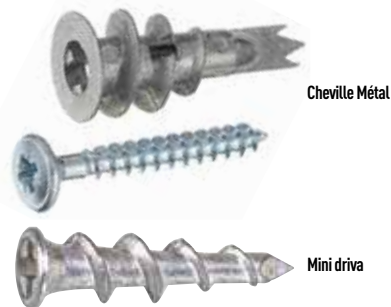

Refs.	désignation	L mm	Øvis x Lvis mm	tfix mm	EP mm
4474F	cheville METAL autoperceuse + vis tête ronde large	31	4.5 x 30	15	10 - 20
4715G	cheville MINI DRIVA autoperceuse	26	-	5	-

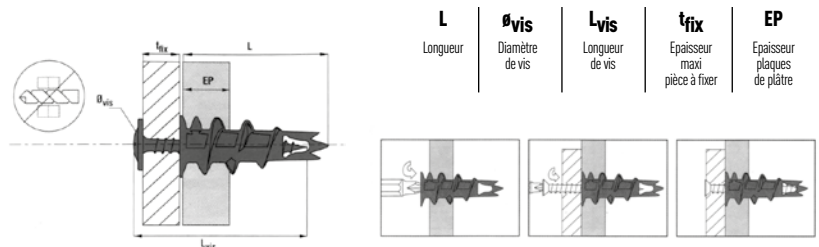

- Pose rapide à la visseuse sans perçage préalable.
- Version métal très résistante à la chaleur d'où son utilisation pour la fixation de convecteur.
- Matériaux : plaques de plâtre.

### CHEVILLE A FRAPPER

- Pas besoin d'outil spécifique, le vissage met la cheville en expansion.
- Profil plat de la cheville enlève tout risque de rotation au vissage.
- Matériaux : carreaux de plâtre, béton cellulaire.



Refs.	L mm	Ø vis mm
4885H	50	4.0

## CLOUEUR SENCO



**4481N**  
CLOUEUR A GAZ BETON SENCO  
GT40I-SCP 15 à 40mm  
+ 2 batteries + chargeur

**7178D** CARTOUCHE DE GAZ  
SENCO 40G x 2

**4969T** PACK 1000 CLOUS BETON  
DUR/ACIER 3X19+GAZ

**6579K** PACK 1000 CLOUS BETON  
2.7X19 + GAZ 40G



# FIXATION

## 203 CHEVILLE NYLON

### CHEVILLE DUO POWER

#### A utiliser dans :

- Bétons, parpaings pleins, parpaings à perforations verticales, parpaings creux, briques pleines, briques creuses, briques alvéolaires, bétons cellulaires, carreaux de plâtre, tous les matériaux en plaque, etc.

#### Description :

- Le polyamide (nylon) de très grande qualité garantit la résistance aux intempéries et au vieillissement
- Bonne résistance aux produits chimiques
- Matériau résistant et élastique
- Plage des températures d'utilisation : -40° à +80°C



Refs	Ø	
6340X	06	6 X 30
6341Y	08	8 X 40
6534P	08	8 X 65
6342Z	10	10 X 50
6532M	14	14 X 70
6533N	12	12 X 60

### CHEVILLE MULTI-USAGES PC

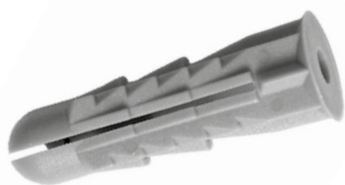

#### A utiliser dans :

- Matériaux de construction pleins ou creux
- Panneaux, Carton-plâtre

#### Avantages :

- La collerette et les stries de blocage empêchent la rotation de la cheville
- Corps de la cheville fendu et évidé dans la partie supérieur pour le guidage de la vis

Type	Refs.	Ø de foret d <sub>0</sub> (mm)	perçage mini t (mm)	Long. cheville (mm)	vis à bois Ø (mm)
P 6 C	2189E	6	35	27	2-5
P 8 C	2223Q	8	40	34	4-6
P 10 C	2191G	10	60	53	5-8
P 8 PAV	2190F	8	40	34	5-8

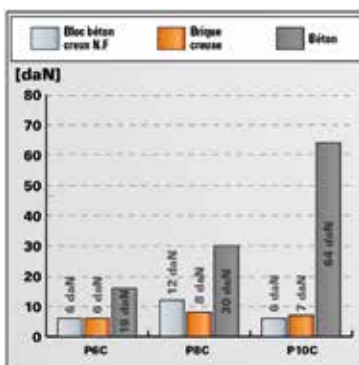

#### Fixation multi-usages PC

- Charges admissibles maximales en traction Nadm. A utiliser avec vis à bois et vis pour panneau d'aggloméré ou patte à vis (selon le type).

- Pour les caractéristiques exactes de résistance et de pose, il convient de se référer à la fiche technique du produit. Les charges indiquées tiennent compte de coefficients de sécurité.

### CHEVILLE GALAXY



#### Matériaux :

- Béton
- Maçonnerie pleine
- Maçonnerie creuse

#### Avantages :

- Quadruple expansion qui garantit une fixation sûre et résistante.
- Ergot de blocage anti-rotation pour vissage plus sûr.
- Très bonne résistance aux intempéries et au vieillissement.
- Colerette de blocage (ne glisse pas dans le trou de forage).

Type	Refs.	Ø de foret d <sub>0</sub> (mm)	perçage mini t (mm)	Long. cheville h <sub>ef</sub> (mm)	vis à bois d <sub>s</sub> (mm)
5 X 25	6194V	5	45	25	3 - 4
6 X 30	4760C	6	45	30	4 - 5
8 X 40	4761D	8	55	40	4,5 - 6
10 X 50	4762E	10	65	50	6 - 8
12 X 60	5172Y	12	80	60	8 - 10
14 X 70	6199A	10	90	70	10 - 12

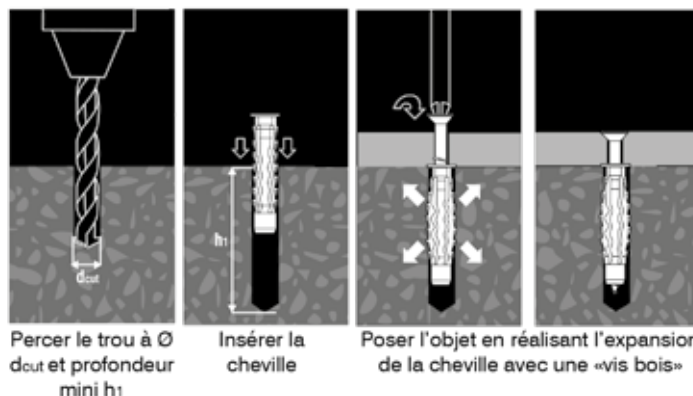



## 207 CHEVILLE A FRAPPER



### A utiliser dans :

- Béton
- Pierre / Parpaing
- Béton cellulaire
- Brique pleine / creuse

### Pour fixer :

- Plinthes, chevrons...
- Structures secondaires...

### Avantages :

- Un design novateur permettant un excellent guidage du clou lors de la pose
- Clou fileté pour un démontage possible
- Cheville prémontée pour une pose rapide

Ø	Refs.	L	d <sub>cut</sub>	h <sub>1</sub>	t <sub>fix</sub>
		mm	mm	mm	mm
5.0	0723C	27	5	25	5
	0895G	37	5	25	15
	0896H	47	5	25	25
6.0	0897J	40	6	30	10
	0898K	55	6	30	25
	0899L	67	6	30	37
8.0	3311V	45	8	40	5
	0900M	60	8	40	20
	0901M	75	8	40	35
	0902P	100	8	40	60
	2338K	120	8	40	80

## CHEVILLE DE SUSPENSION RAPCO



Ref	d <sub>cut</sub> mm
3374L	8

## GOUJON A OEIL 6x60



Ref	
6292X	6 X 60

## 197 CHEVILLE BETON CELLULAIRE

### CHEVILLE BETON CELLULAIRE



### Agrément :

- Béton cellulaire. >PB2, PP2 (G2)

Type	Refs.
GB 8	3030T
GB 10	3031U
GB 14	4186T

### CHEVILLE BETON CELLULAIRE FPX M10



Refs.
6384K

## CROCHET SANS CHEVILLE + OUTIL POSE



Ref
1822X

## 192 VIS BETON

### VIS BETON

Refs	Dim	Ø
6103W	6 X 80	PERCAGE Ø 06
6020K	8 X 55	PERCAGE Ø 08
6043J	8 X 70	PERCAGE Ø 08
6044K	8 X 80	PERCAGE Ø 08
6745A	10 X 60	PERCAGE Ø 10
6740V	10 X 90	PERCAGE Ø 10
5332S	10 X 100	PERCAGE Ø 10
6368T	10 X 140	PERCAGE Ø 10
6741W	10 X 200	PERCAGE Ø 10
6743Y	Tête fraisée 6 X 120	PERCAGE Ø 06
6742X	Tête fraisée 10 X 180	PERCAGE Ø 10



### PITON FEMELLE BETON

Refs	Dim	Ø
4154K	M10 BT-I-M10	PERCAGE Ø 6
4153J	M8 BT-I-M08	PERCAGE Ø 6

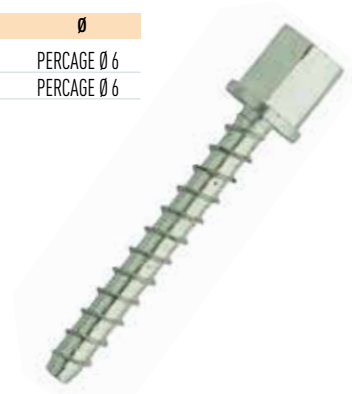

# FIXATION

## 191 SCÉLÈMENT CHIMIQUE

### SCÉLÈMENT POLYVALENT

- Scellement polyester multi-matériaux : supports creux et pleins

Ref 3013J 300ml



### KIT FIXATION CHIMIQUE



Ref 4187U KIT FIXATION CHIMIQUE

### TAMIS PLASTIQUE M



Refs	
3532U	12 X 50
2102P	16 X 85
2928Z	16 X 130
3976B	20 X 85

### CANULE MÉLANGEUSE POUR MORTIER



Ref 2101N

### PISTOLET MORTIER



Ref 3014K 380 ml

### POMPE SOUFFLANTE



Ref 2092D

## 208 BASCULE ET CHEVILLE RESSORT

### CHEVILLE À BASCULE AVEC ROSACE

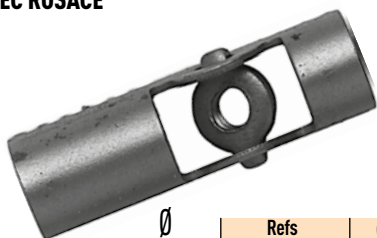

**d<sub>cut</sub>**  
Diamètre de perçage

Ø	Refs	d <sub>cut</sub> mm
M 5	4403U	15
M 6	0022X	18
M 7	6134H	
M 8	0687Q	20

### CHEVILLE À RESSORT

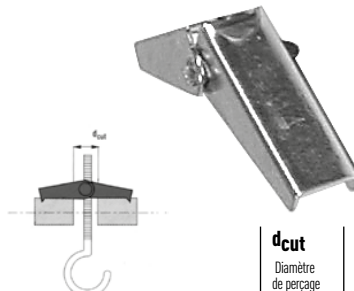

**d<sub>cut</sub>**  
Diamètre de perçage

Ø	Refs	d <sub>cut</sub> mm
M 6	2518X	18
M 8	6116K	

### BASCULE LOURDE MONTÉE

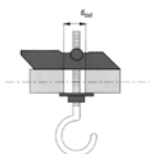

Refs	Ø x Lg
3977C	8 X 100
3978D	10 X 100

### OUILLET A VIS



Refs	Ø x Lg
0285W	6 X 40
0016R	6 X 110
6437P	8 X 200
6438Q	10 X 200

### CROCHET M



Refs	Ø x Lg
0019U	6 X 40
2427C	6 X 70

## 159 COLLIER DE SERRAGE ZINGUE

### COLLIER SERRAGE

Refs	Ø	Larg/mm
2339L	8 / 16	9
2342P	12 / 22	9
2340M	16 / 27	9
5817A	20 / 32	9
2343Q	25 / 40	9
5818B	35 / 50	9
2344R	40 / 60	9
2296R	60 / 80	9



EXISTE  
EN VERSION  
INOX

### BANDE INOX

Refs	Dim
2346T	Bande 9 mm - Rouleau 30 ml
2345S	Tête de bande 9 mm - Bte 50



## 161 COLLIER ELECTRICIEN ET ACCESSOIRES

### BERCEAU A VISSER NOIR



Ref 1943Y Largeur 9

### CHEVILLE STANDARD NOIR



Ref 1908M

### COLLIER CABLAGE



Refs	Dim	Coul.
1944Z	2,5 X 100	NOIR
2003L	2,5 X 200	NOIR
1945A	3,6 X 140	NOIR
1946B	4,7 X 200	NOIR
1947C	4,8 X 300	NOIR
6495Y	4,8 X 370	NOIR
3383V	7,6 X 200	NOIR
3384W	7,6 X 300	NOIR
1729A	7,8 X 370	NOIR
4473E	8,8 X 770	NOIR
3847T	2,5 X 100	BLANC
3848U	3,6 X 140	BLANC
3933G	3,6 X 200	BLANC
3849V	4,8 X 203	BLANC
3850W	4,8 X 300	BLANC
6494X	4,8 X 370	BLANC
6119P	7,8 X 370	BLANC
1748V	12,5 X 1000	BLANC

### COLLIER POLYAMIDE



Refs	Dim	Coul.
3844Q	9 X 180	NOIR
3845R	9 X 260	NOIR
3846S	9 X 360	NOIR
5014P	9 X 510	NOIR
4731X	9 X 760	NOIR

### PINCE POSE COLLIER



Ref 2925W collier de 9

## 175 CABLE DE SUSPENSION RAPIDE

### KIT BOBINE + VERROU

Refs.	Dim	Resist.	Long
3544G	CABLE ACIER 1.5mm	35 KG	150 ML
3334U	CABLE ACIER 2.5mm	70 KG	150 ML
3413B	VERROU DE BLOCAGE 1.5-2.5	70 KG	



### CABLE EMBOUT BOUCLE ET BOX CABLE

Refs.	Long. cm	Support Kg
4183Q	2 M	10 KG
4194B	1 M	45 KG
4195C	2 M	45 KG
4196D	3 M	45 KG
4197E	5 M	45 KG
4198F	10 M	45 KG

Refs.	Long. cm	Support Kg
4199G	3 M	90 KG
4200H	5 M	90 KG
4201J	10 M	90 KG
4202K	4 M	300 KG
4559U	5 M	300 KG
4560V	10 M	300 KG



### CABLE DE SUSPENSION EASY LOCK EMBOUT ANCRE

Refs	Dim	Poids
5800A	1 ML	35 KG
5801H	2 ML	35 KG
5802J	3 ML	35 KG
5803K	5 ML	35 KG



### ANNEAU LEVAGE ZINGUÉ

Refs		
1017J	Mâle	6 X 15
1018K	Mâle	8 X 12
1010B	Mâle	10 X 17
2029U	Mâle	12 X 40
3616G	Femelle	6
1011C	Femelle	8
1012D	Femelle	10
6028T	Femelle	12



### PINCE COUPE CABLE BKCC



Ref 6221Y PINCE COUPE CABLE BKCC

# ASSEMBLAGE

## 047 VIS AUTOPERCEUSE TÊTE SIX PANS

EXISTE EN VERSION INOX

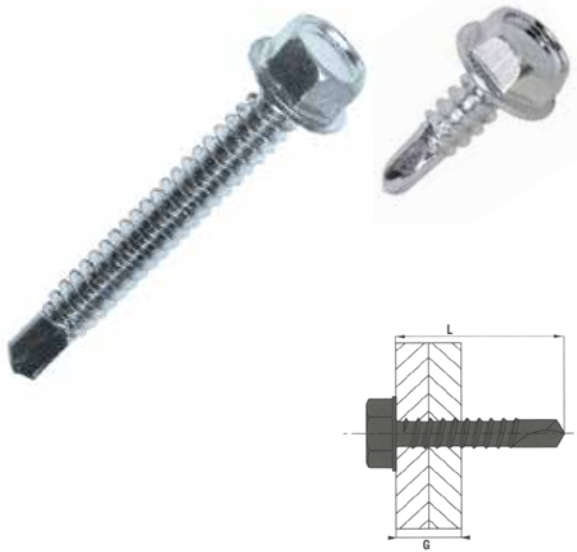

L \ Ø	4.2				4.8				6.3			
	S	P	G		S	P	G		S	P	G	
10												
13				6	2417S			4				
16				9	2418T			7				
19				12	1225A			10			8	
22		7	3	15							11	
25				18	2419U	8	4	16	2422X		14	
32				25	2420V			23	2423Y		21	
38					2421W			29	1227C		27	
45					1934P			36	2425A	10	6	
50					1935Q			41			39	
60											52	
75											64	
80												
100											89	

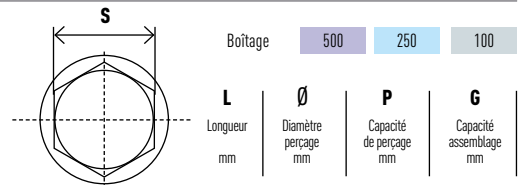

Boitage 500 250 100

**L** Longueur mm  
**Ø** Diamètre perçage mm  
**P** Capacité de perçage mm  
**G** Capacité assemblage mm



1207G RONDELLE ETANCHE Ac/Néoprène 14 X 5  
 1208H RONDELLE ETANCHE Ac/Néoprène 19 X 6.5

## 048 VIS AUTOPERCEUSE TÊTE RONDE PHILIPS

EXISTE EN VERSION INOX

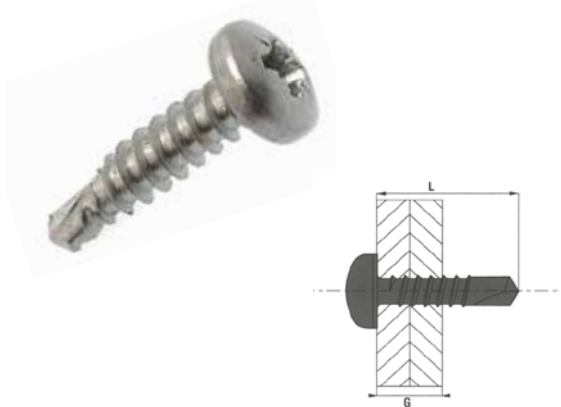

L \ Ø	3.5				3.9				4.2				4.8			
	M	P	G		M	P	G	M	P	G	M	P	G			
10																
13				7	2402B			7	2406 F		6	1883L	4			
16				10	2403C			10	2407G		9	2409J	7			
19				13	2404D			13	2408H		12	2410K	10			
22				-		4.4	2.5		1880H	4.6	3	1844M	4.6			
25				19	2405E			19	1881J		18	2411L	13			
32					1879G			26	1882K		25	2412M	23			
38									1590 F		31	2413N	29			
45												1885N	36			

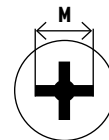

Boitage 500 250 100

**L** Longueur mm  
**Ø** Diamètre perçage mm  
**P** Capacité de perçage mm  
**G** Capacité assemblage mm

## 050 VIS AUTOPERCEUSE TÊTE RONDE ZINGUÉE EMPREINTE CARRÉE

EXISTE EN VERSION INOX

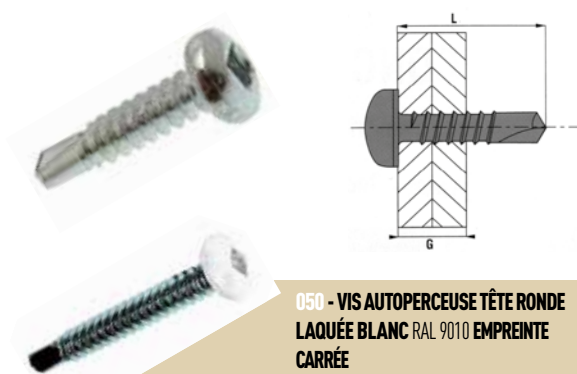

050 - VIS AUTOPERCEUSE TÊTE RONDE LAQUÉE BLANC RAL 9010 EMPREINTE CARRÉE

L \ Ø	3.5			4.2			4.8		
	P	G		P	G	P	G		
10									
13			2	2760Z		6	4811F	4	
16				2761A		9	2762B	7	
19				2831Y	3	12	2763C	10	
22								4	
25				2832Z		18	3629V	16	
32							4812G	23	
38							4813H	29	

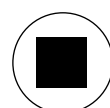

Boitage 500 250

**L** Longueur mm  
**Ø** Diamètre perçage mm  
**P** Capacité de perçage mm  
**G** Capacité assemblage mm

**049 VIS AUTOPERCEUSE TÊTE FRAISÉE EMPREINTE PHILIPS** **EXISTE EN VERSION INOX**

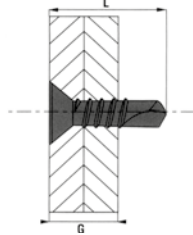

L	Ø	3.5	M	P	G	3.9	M	P	G	4.2	M	P	G	4.8	M	P	G
13										0545S			6	4806A			4
16	0142X	4.2	2	7		0139U			10	0884V			9	0887Y			7
19						0701E			13	0855W			12	0920H			10
22						4803X	4.6	2.5	16				15				13
25	0137S	4.2	2	10		0544R			19	0886X	4.7	3	18	0910X	4.6	3	16
32						1902F			26	1905J			25	0916D			23
38						1903G			32	1906K			31	0917E			29
45														1907L			36
50														0919G			
65														4807B			

Boitage

500 250

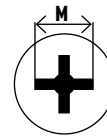

**L** Longueur mm  
**Ø** Diamètre perçage mm  
**P** Capacité de perçage mm  
**G** Capacité assemblage mm

**049 VIS AUTOPERCEUSE TÊTE FRAISÉE EMPREINTE CARRÉE** **EXISTE EN VERSION INOX**

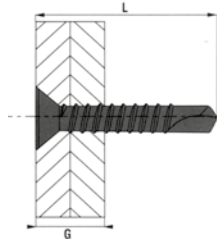

L	Ø	3.9	P	G	4.2	P	G	4.8	P	G
13		6738T		7				6739U		4
16		4996V		10	5003C			5010K		7
19		4997W		13	5004D			5011L		10
22										
25		4999Y		2.5	19	5005E	3	18	5012M	16
32		5000Z		26	5006F			25	5013P	23
38		5001A		32	5007G			31	5015Q	29
45									5016R	36
50									5017S	41
60									5018T	51
70									5019U	61
80									5020V	71

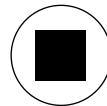

**L** Longueur mm  
**Ø** Diamètre perçage mm  
**P** Capacité de perçage mm  
**G** Capacité assemblage mm

**049 VIS AUTOPERCEUSE TÊTE FRAISÉE À AILETTE EMPREINTE TORX**

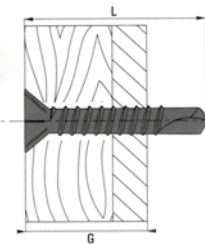

L	Ø	6.3	P	G
50		2226T		36
63		2227U		46
70		1956M	6	56
80		1957N		65

**L** Longueur mm  
**Ø** Diamètre perçage mm  
**P** Capacité de perçage mm  
**G** Capacité assemblage mm



Boitage 200

**049 VIS AUTOPERCEUSE TÊTE LARGE PHILIPS ZINGUÉE**

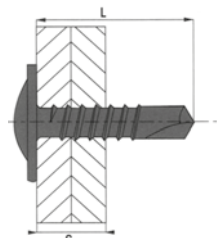

L	Ø	4.2	P	G
13		3627T		6
19		4910H	3	
25		3628U		18

**L** Longueur mm  
**Ø** Diamètre perçage mm  
**P** Capacité de perçage mm  
**G** Capacité assemblage mm





# ASSEMBLAGE

## 077 VIS BOIS TÊTE FRAISÉE ZINGUÉE POZIDRIV

- Tête renforcée auto-fraisante
- Pointe anti-fendage
- Filetage bois

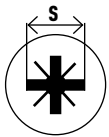

L	3	3.5	4	4.5	5	6
10						
12	2354B	3617H				
16	0807Q	0812V	0818B			
20	0808R	0813W	0819C	0826K	0834T	
25	0809S	0814X	0820D	0827L	0835U	
30	0810T	0815Y	0821E	0828M	0836V	
35	0811U	0816Z	0822F	0829N	0837W	
40	3851X	0817A	0823G	0830P	0838X	0844D
45			0824H	0831Q	0839Y	
50		3307V	0825J	0832R	0840Z	0845E
60			3402Q	0833S	0841A	0846F
70			3872U	4110P	0842B	0847G
80				3860G	0843C	0848H
90					3401P	0849J
100					2449A	0850K
120					1878D	0851L
140						2448Z
160						2153S
180						3362Y
200						3363Z

	3	3.5	4	4.5	5	6
S	5,6 / 5,9	6,6 / 6,9	7,6 / 7,9	8,6 / 8,9	9,6 / 9,9	11,5 / 11,9

Boitage 500 200 100

## INOX

2933E	TFPZ A2	3 X 12
2934F	TFPZ A2	3 X 16
2935G	TFPZ A2	3 X 20
2936H	TFPZ A2	3 X 25
2937J	TFPZ A2	3 X 30
2938K	TFPZ A2	4 X 16
2939L	TFPZ A2	4 X 20
2940M	TFPZ A2	4 X 25
2941N	TFPZ A2	4 X 30
2942P	TFPZ A2	4 X 35
2943Q	TFPZ A2	4 X 40
7045Q	TFPZ A2	4 X 70
2944R	TFPZ A2	5 X 25
2945S	TFPZ A2	5 X 30
2946T	TFPZ A2	5 X 35
2947U	TFPZ A2	5 X 40
2948V	TFPZ A2	5 X 45
2949W	TFPZ A2	5 X 50
2680R	TFPZ A2	5 X 60
7046R	TFPZ A2	5 X 70
7047S	TFPZ A2	6 X 40
7048T	TFPZ A2	6 X 50

## 012 VIS METAUX 8,8 SIX PANS ZINGUÉE FILETAGE TOTAL

- DIN 933
- NF EN ISO 4017



L	4	5	6	8	10	12	14	16
12	3404S	2351Y			6592Y			
16	0519Q	0537J	1167Q	1180D	1377J	1614F		
20	0523U	0539L	1168R	1181E	1378K	1615G		
25	0524V	0540M	1169S	1182F	1379L	1620M	0689S	1544H
30	0154K	0541N	1170T	1183G	1379L	1620M	0690T	1545J
35	0691U	2104R	1172V	1184H	0305S	1622P	2310 F	1546K
40	0156M	2105S	1173W	1185J	2014X	1623Q		2711Y
45		2106T	1174X	1206F	1031Y	2352Z		
50		2107U	1175Y	1607Y	1030X	0220D	0529A	1547L
60			2085W	1374F	1610B	0892D	0020V	2130T
70				1375G	1611C	2075L		0362B
80				2082T	2079Q	2076M		2032R
100					2081S	2078P		2074K

	M5	M6	M8	M10	M12	M14	M16
S	-	8	10	13	16	18	21

Boitage 500 200 100 50 25 10

## INOX

1992Z	6 X 16	2285E	12 X 30
2274T	6 X 20	2499C	12 X 35
2275U	6 X 30	2286F	12 X 40
2276V	6 X 40	2287G	12 X 50
2511Q	6 X 50	4795P	12 X 55
2487Q	6 X 60	2500D	12 X 60
2996R	6 X 70	2501E	12 X 70
3615F	8 X 10	2502F	12 X 80
2277W	8 X 20	2503G	14 X 30
2278X	8 X 25	2504H	14 X 35
2279Y	8 X 30	2505J	14 X 40
1942X	8 X 35	2506K	14 X 50
2280Z	8 X 40	2507L	14 X 60
2281A	8 X 50	4794N	14 X 80
2488R	8 X 60	2236D	16 X 20
2490T	8 X 70	4793M	16 X 25
2489S	8 X 80	7049U	16 X 30
2491U	10 X 20	2510P	16 X 40
2492V	10 X 25	2508M	16 X 50
2282B	10 X 30	2288H	16 X 60
2493W	10 X 35	2289J	16 X 70
2283C	10 X 40	2509N	16 X 80
4797R	10 X 45	3309X	16 X 90
2284D	10 X 50	3310Y	16 X 100
2494X	10 X 60	7050V	18 X 50
2495Y	10 X 70	7051W	18 X 90
2496Z	10 X 80	2551G	20 X 60
4796Q	10 X 100	6442U	20 X 90
2497A	12 X 20	4792L	22 X 60
2498B	12 X 25	7052X	24 X 90

## 109 VIS AUTOTARAUDEUSE INDEX AUE



L	6.3
32	1733E
50	1735G



## 007 BOULON TRCC ZINGUÉ

- DIN 963
- NF EN ISO 2009



Boitage 200 100

L	6	8
20	1496H	1568H
25	1549N	
30	1550P	1569J
35	1551Q	1570K
40	1552R	1571L
45	1553S	
50	1554T	1573N
60	1555U	1574P
70	1556V	1575Q
80	1557W	1576R
90	1558X	
100	1559Y	3656Y

## 038 VIS POELIER ZINGUÉ

- NF E 25129

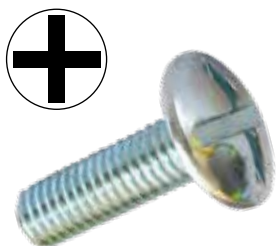

L	4	5	6	8	10
10	1403L	1411U	1420D		
12		3624Q	3625R		
16	1404M	1412V	1421E		
20	1405N	1413W	1422F	1431Q	
25	1406P	1414X	1423G	1432R	
30	1407Q	1415Y	1424H	1433S	1440Z
35	1408R	1416Z	1425J	1434T	
40	1409S	1417A	1426K	1435U	1441A
50	1410T	1418B	1427L	1436V	1442B
60		1419C	1428M	1437W	1443C
70			1429N	1438X	
80			1430P	1439Y	

Boitage 500 200 100 50

## 034 BOULONNERIE CHEMIN CABLE

- BOULON TRCC

L	6
12	0134P
16	0135Q
20	0136R
30	4735B

- COLLET REDUIT

L	6
20	3380S



- ECRU H EMBASE CRANTEE BI

	6	8	10	12
BI	3772Q	3773R	4630T	4866N
ZB	0690B	0718X		



## 009 VIS BOIS SIX PANS ZINGUÉ

- DIN 571
- NF E 25607



L	5	6	8	10	12
25	1667L	1672R			
30	1668M	1673S	1690K		
35	1669N	1674T			
40	1670P	1675U	1691L	1701W	
45		1676V	1692M		
50		1677W	1693N	1702X	1710F
60		1678X	1694P	1703Y	1711G
70		1679Y	1695Q	1704Z	1712H
80		1680Z	1696R	1705A	1713J
90			1697S	1706B	
100			1698T	1707C	1714K
120			1699U	1708D	1715L
140			1700V	1709E	1716M
160					1717N
180					1718P

S	5	6	8	10	12
S	8	10	13	17	19

Boitage 200 100 50 25

## INOX

2992M	VIS BOIS H	6 X 40
2993N	VIS BOIS H	6 X 50
2994P	VIS BOIS H	6 X 60
3020J	VIS BOIS H	6 X 80
2995Q	VIS BOIS H	8 X 50
2913J	VIS BOIS H	8 X 60
2914K	VIS BOIS H	8 X 70
2932D	VIS BOIS H	8 X 80
4791K	VIS BOIS H	10 X 40

# ASSEMBLAGE

## 028 TIGE FILETÉE ZINGUÉE

- DIN 975
- NF E 25136



L	3	4	5	6	7/150	8	10	12
1ML	0603C	0604D	0605E	0606F	0608H	0609J	0610K	0611L
2ML				2373W		2450B	4105J	5146X
3ML				1232H		4977B	5145W	5147Y

L	14	16	18	20	22	24	27	30
1ML	0612M	0613N	0614P	0615Q	0616R	0617S	0618T	0619U

## INOX

0620V	TIGE FILETEE A2	4
0621W	TIGE FILETEE A2	5
0622X	TIGE FILETEE A2	6
0623Y	TIGE FILETEE A2	8
0624Z	TIGE FILETEE A2	10
6620V	TIGE FILETEE A2	10 2ML
6622X	TIGE FILETEE A2	10 3ML
0625A	TIGE FILETEE A2	12
6621W	TIGE FILETEE A2	12 2ML
6623Y	TIGE FILETEE A2	12 3ML
0626B	TIGE FILETEE A2	14
0627C	TIGE FILETEE A2	16
2244M	TIGE FILETEE A2	18
2245N	TIGE FILETEE A2	20

## 059 RONDELLE "CARROSSIER" ZINGUÉE

- DIN 522

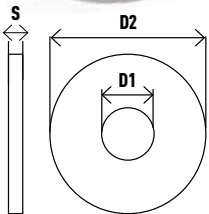

L	4-25	5-25	6-25	7-30	8-35	10-30	12-32	14-32
S	1.2	1.5	1.5	1.5	1.5	1.5	2	2
D1	4	5	6	7	8	10	12	14
D2	25	25	25	30	35	30	32	32
REFS	0676D	0677E	0678F	0679G	0680H	0681J	0682K	0623L

## 055 RONDELLE MOYENNE ZINGUÉE

- NF E 25513

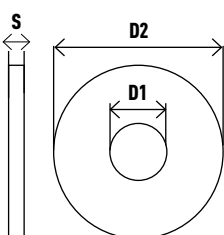

L	3-8	4-10	5-12	6-14	7-16	8-18	10-22	12-27
S	0.8	0.8	1.0	1.2	1.5	1.5	2	2.5
D1	3	4	5	6	7	8	10	12
D2	8	10	12	14	16	18	22	27
REFS	0650B	0651C	0652D	0653E	0654F	0655G	0656H	0657J

L	14-30	16-32	18-36	20-40	22-45	24-50	27-55	30-60
S	2.5	3.0	3.0	3.0	3.0	4.0	4.0	4.0
D1	14	16	18	20	22	24	27	30
D2	30	32	36	40	45	50	55	60
REFS	0658K	0659L	0660M	0661N	0654F	0663Q	0664R	0665S

Boitage    1000    500    200    100    50    25

## INOX

1984R	RONDELLE MU A2	4
1985S	RONDELLE MU A2	5
1986T	RONDELLE MU A2	6
1987U	RONDELLE MU A2	8
1988V	RONDELLE MU A2	10
1989W	RONDELLE MU A2	12
1990X	RONDELLE MU A2	14
1991Y	RONDELLE MU A2	16
2246P	RONDELLE MU A2	18
2247Q	RONDELLE MU A2	20
3604U	RONDELLE MU A2	22
6550E	RONDELLE MU A2	24
4838J	RONDELLE MU A2	27

3326L	RONDELLE MU A4	8
3327M	RONDELLE MU A4	10
3328N	RONDELLE MU A4	14

## 056 RONDELLE LARGE ZINGUÉE

• NF E 25513

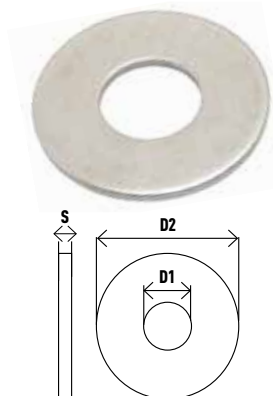

L	6-18	7-20	8-22	10-27	12-32	14-36	16-40	18-45
S	1.2	1.2	1.2	2.0	2.5	2.5	3.0	3.0
D1	6	7	8	10	12	14	16	18
D2	18	20	22	27	32	36	40	45
REFS	0704H	2141E	0048Z	2119G	2099L	1051U	0684M	0685N

L	20-50	22-55	24-60
S	3.0	3.0	3.0
D1	20	22	24
D2	50	55	60
REFS	0686P	1862P	1863Q

Boitage 1000 500 200 100 50 25

## INOX

2565W	RONDELLE LU A2	4 X 14
2578K	RONDELLE LU A2	5 X 16
2577J	RONDELLE LU A2	6 X 18
3605V	RONDELLE LU A2	6 X 24
2573E	RONDELLE LU A2	8 X 22
3606W	RONDELLE LU A2	8 X 30
2564V	RONDELLE LU A2	10 X 27
2576H	RONDELLE LU A2	12 X 32
6410L	RONDELLE LU A2	16 X 40
6508M	RONDELLE LU A2	20 X 50

## 061 RONDELLE GROWER ZINGUÉE

• NF E 25515

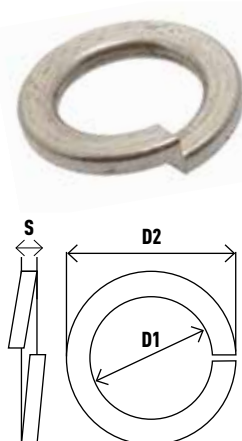

L	4	5	6	7	8	10	12
S	1.0	1.5	2.0	2.0	2.5	3.0	3.5
D1	3.5	5.5	6.5	7.5	8.5	10.5	13
D2	5.2	8.3	10.4	11.4	13.4	16.5	20
REFS	0473S	0474T	0477W	0476V	0475U	0478X	0479Y

L	14	16	18	20	22	24
S	4.0	4.0	5.0	5.0	5.0	6.0
D1	15	17	19	21	23	25
D2	23	25	29	31	33	37
REFS	0480Z	0481A	0482B	0483C	0484D	0485E

Boitage 1000 500 200 100 50

## INOX

4143Y	RONDELLE GROWER A2	4
4144Z	RONDELLE GROWER A2	5
4145A	RONDELLE GROWER A2	6
4146B	RONDELLE GROWER A2	8
3321F	RONDELLE GROWER A2	10
4147C	RONDELLE GROWER A2	12
4148D	RONDELLE GROWER A2	14
4149E	RONDELLE GROWER A2	16
7040K	RONDELLE GROWER A2	18
7041L	RONDELLE GROWER A2	22

## 062 RONDELLE ÉVENTAIL ZINGUÉE

• DIN 6798  
• NF E 27624

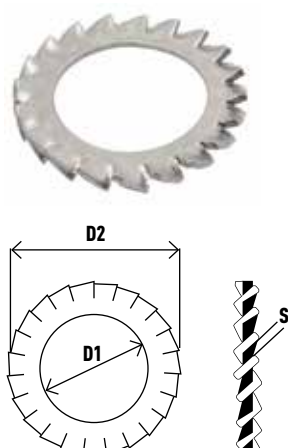

L	3	4	5	6	8	10	12
S	0.4	0.5	0.6	0.7	0.8	0.9	1.0
D1	3	4	5	6	8	10	12
D2	6	8	9.2	11	14	18	20
REFS	0486F	0487G	0488H	0489J	0490K	0491L	0492M

L	14	16	18	20
S	1.1	1.2	1.4	1.4
D1	14	16	18.5	20.5
D2	24	26	30	32.5
REFS	0493N	0494P	0495Q	0496R

Boitage 1000 500 250 50

## INOX

3607X	RONDELLE ÉVENTAIL A2 AZ	4
4837H	RONDELLE ÉVENTAIL A2 AZ	6
4957F	RONDELLE ÉVENTAIL A2 AZ	8
3318C	RONDELLE ÉVENTAIL A2 AZ	10
3319D	RONDELLE ÉVENTAIL A2 AZ	12
3608Y	RONDELLE ÉVENTAIL A2 AZ	14
3320E	RONDELLE ÉVENTAIL A2 AZ	16
3609Z	RONDELLE ÉVENTAIL A2 AZ	18
3610A	RONDELLE ÉVENTAIL A2 AZ	20
3611B	RONDELLE ÉVENTAIL A2 AZ	22

# ASSEMBLAGE

## 004 ÉCROU SIX PANS ZINGUÉ

• NF EN ISO 4032

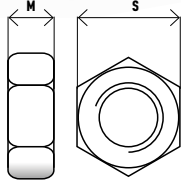

L	3	4	5	6	7/150	8	10	12
S	5.5	7	8	10	-	13	16	18
M	2.4	3.2	4.7	5.2	-	8.4	8.4	10.8
REFS	1628V	1629W	1630X	1631Y	1242T	1633A	1634B	1635C

L	14	16	18	20	22	24	27	30
S	21	24	27	30	34	36	41	46
M	12.8	14.8	15.8	18	19.4	21.5	23.8	25.6
REFS	1636D	1637E	1638F	1639G	1640H	1641J	1642K	1643L

Boitage 200 100 50 25 10

### INOX

3602S	ECROU HU A2	3
0028D	ECROU HU A2	4
0029E	ECROU HU A2	5
0030F	ECROU HU A2	6
0031G	ECROU HU A2	8
0032H	ECROU HU A2	10
1981N	ECROU HU A2	12
1982P	ECROU HU A2	14
1983Q	ECROU HU A2	16
2248R	ECROU HU A2	18
1195U	ECROU HU A2	20
3603T	ECROU HU A2	22
6551F	ECROU HU A2	24
4836G	ECROU HU A2	36
5175B	ECROU HU A4	16

## 032 ÉCROU AUTOFREINÉ BAGUE NYLON

• NF EN ISO 4033

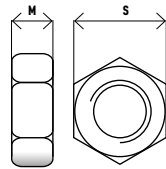

L	4	5	6	8	10
S	7	8	10	13	15
M	5	5	6	8	10
REFS	1655Y	1656Z	1657A	1658B	1659C

L	12	14	16	18	20
S	18	21	24	-	-
M	12	14	16	18	20
REFS	1660D	1661E	1662F	1636G	1664H

Boitage 200 100 50 25

### INOX

3192W	ECROU FREIN A2	4
2972V	ECROU FREIN A2	5
0933W	ECROU FREIN A2	6
2639Y	ECROU FREIN A2	8
0907U	ECROU FREIN A2	10
0908V	ECROU FREIN A2	12
0862X	ECROU FREIN A2	14
0911Y	ECROU FREIN A2	16

## 031 ÉCROU BORGNE ZINGUÉ

• DIN 1587

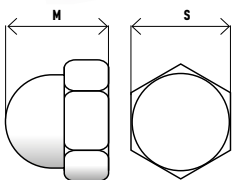

L	4	5	6	8	10	12
S	7	8	10	13	17	19
M	8	10	12	15	18	22
REFS	1644M	1645M	1646P	1647Q	1648R	4801V

Boitage 200 100

### INOX

3892Q	ECROU BORGNE A2 M 5
3893S	ECROU BORGNE A2 M 6
3894S	ECROU BORGNE A2 M 8
4835F	ECROU BORGNE A2 M 10

## 083 ÉCROU À OREILLES ZINGUÉ

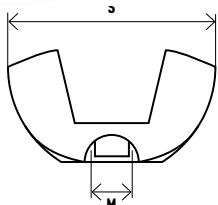

L	4	5	6	8	10	12
S	18.5	22	27	30	35	65
M	9	10.5	9	8	17	30
REFS	1649S	1650T	1651U	1652V	1653W	1654X

Boitage 200 100

## 251 RALLONGE ET MANCHONS

### • RALLONGE MF

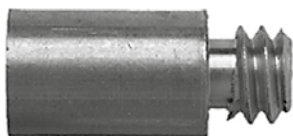

2168H	RALLONGE MF	7 / 150	10
5842B	RALLONGE MF	7 / 150	15
0445N	RALLONGE MF	7 / 150	20
5843C	RALLONGE MF	7 / 150	25
2169J	RALLONGE MF	7 / 150	30
5844D	RALLONGE MF	7 / 150	35
0446P	RALLONGE MF	7 / 150	40
0706K	RALLONGE MF	7 / 150	50
6128B	RALLONGE MF	7 / 150	60
5845E	RALLONGE MF	7 / 150	80
2773N	RALLONGE MF	8 / 125	20
4823T	RALLONGE MF	8 / 125	30

### • MANCHON

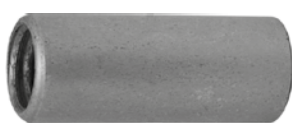

0448R	MANCHON	M 6	30
2027L	MANCHON	7 / 150	30
0449S	MANCHON	M 8	30
2397W	MANCHON	M10	30
2372V	MANCHON	M12	35

### INOX

3336W	MANCHON A2	M 8 X 30
1753A	MANCHON A2	M 10 X 30

### • RACCORD MÂLE / MÂLE



2709W	RACCORD MÂLE / MÂLE	7 / 150
-------	---------------------	---------

### • ADAPTATEUR HEX



3406U	ADAPTATEUR HEX	F8 / 125	M7 / 150
3588C	ADAPTATEUR HEX	M8 / 125	F7 / 150

## 295 VISSERIE NYLON

### • ECROU HU NYLON

Ø ▶	M6	M8	M10
REFS	3948X	3357T	3358U



### • RONDELLE MU NYLON

Ø ▶	M6	M8	M10
REFS	3359V	3360W	3962B



### • TIGE FILETÉE NYLON

Ø ▶	M6	M8	M10
REFS	3949Y	3950Z	3951A



## 296 CACHE ÉCROU

### • CAPUCHON H 10



Couleurs ▶	BLANC	NOIR
M6/10	6625A	3391D
M8/13	3587B	3392E
M10/17	6627C	3393F
M12/19	6628D	3394G
M16/24		3395H

### • CHAPEAU 6 PANS

Couleurs ▶	BLANC
REFS	1262P



## 079 VIS PLAQUISTE

### • VIS PLACO



L	Ø	3.5
25		2249S
35		2250T
45		2251U
55		2252V

### • VIS PLACO AUTOPERCEUSE



L	Ø	3.5
25		6582N
35		6583P



# ASSEMBLAGE

## 261 INSERT ET OUTILLAGE



**2376Z** PINCE A ECROU 1 MAIN M3-M 6



**0961A** PINCE A ECROU 2 MAIN M4-M10

• ECROU A SERTIR AC TP



L	M3	M4	M5	M6	M8
15	3302L				
25		2356D			
30			2357E		
60				2 358 F	2359G

• ECROU A SERTIR AC TR



L	M4	M5	M6	M8	M10
15	2360H				
20		2361J	2362K		
25				2363L	3984K

• ECROU A SERTIR AL TF



L	M4	M5	M6	M8
35	2368R			
40		2369S	2370T	2371U

• ECROU A SERTIR AL TP



L	M4	M5	M6	M8
25	2364M			
30		2365N		
40			2366P	
60				2367Q

### INOX

<b>4084M</b>	ECROU A SERTIR INOX TR	4 X 20
<b>4085N</b>	ECROU A SERTIR INOX TP	5 X 20
<b>4086P</b>	ECROU A SERTIR INOX TP	6 X 30
<b>4087Q</b>	ECROU A SERTIR INOX TP	8 X 30
<b>4088R</b>	ECROU A SERTIR INOX TP	10 X 30

• CHEVILLE EPDM

L	M6	M8
16	4904B	
28		4905C



## 255 RIVET ET OUTILLAGE



0719Y PINCE A RIVETER 1 MAIN



0721A PINCE A RIVETER 2 MAINS

• RIVET ALU/ACIER TETE LARGE



L	Ø	4.8
8		0242B
10		5268A
12		0243C
14		5269B
16		0245E
20		0247G
25		0248H
30		0250K
35		0251L

• RIVET ALU/ACIER



L	Ø	3	4	4.8
8		0214X	0222F	0230P
10		0215Y	0223G	
12			0224H	0232R
14		0217A		
16			0226K	0234T
20			0228M	0236V
25			0229N	0238X
30				0239Y
35				0240Z
40				0241A
50				2447Y
60				5267Y

• RIVET BLANC ALU/ACIER



L	Ø	4	4.8
10		3982H	0254P
12		0274K	0257S
16		0275L	0212V
20		7233L	4784C

• RIVET ACIER/ACIER



L	Ø	3	4	4.8
8		0253N	0256R	0260V
12		0255Q	0258T	0261W
16			0259U	0262X

• RIVET ECLATE ALU/ACIER



L	Ø	4
16		3024M

• RIVET GOMULTI ALU



L	Ø	3.2	4.8
8		0272H	
10			0276M
12		0273J	
15			0277N
16			0278P
25			0279Q

### INOX

2593A	RIVET INOX	4 X 8
0720Z	RIVET INOX	4 X 10
2594B	RIVET INOX	4 X 12
2595C	RIVET INOX	4 X 16
2596D	RIVET INOX	4 X 20
2597E	RIVET INOX	4.8 X 10
2598 F	RIVET INOX	4.8 X 14
2599G	RIVET INOX	4.8 X 16
2600H	RIVET INOX	4.8 X 20
2601J	RIVET INOX	4.8 X 25

# ASSEMBLAGE

## 214 MASTICS / MASTIC COLLE ET MOUSSE PU

### MASTIC ACRYLIQUE

2803U	MASTIC ACRYLIQUE BLANC
3001W	MASTIC ACRYLIQUE GRIS
5678D	MASTIC ACRYLIQUE M1 Pot 6 kg



### MASTIC COLLE

3884G	MASTIC COLLE POWER FIX INSTANT STRONG
6383J	MASTIC COLLE MS POLYMERE BLANC
3000V	MASTIC POLYURETHANE BLANC PU40
2804V	MASTIC POLYURETHANE GRIS PU40
4386B	MASTIC POLYURETHANE NOIR PU40
6501E	MASTIC POLYURETHANE SABLE RAL 1015 PU50
7167S	MASTIC POLYURETHANE BLANC POCHE 600ML PU40
5296D	MASTIC PU COLTUILE OCRE 310ml



### MASTIC ET MOUSSE FEU

3880C	MASTIC COUPE-FEU 4HEURES GRIS
3879B	MASTIC HTE TEMPERATURE NOIR 275°C
2536R	MOUSSE PU PISTOLABLE IGNIFUGE



### MASTIC SILICONE SANITAIRE

2810B	MASTIC SANITAIRE FONGICIDE BLANC
3876Y	MASTIC SANITAIRE FONGICIDE TRANSLUCIDE



### MASTIC EXTERIEUR

2807Y	MASTIC SILICONE MENUISERIE BLANC
2806X	MASTIC SILICONE MENUISERIE TRANSLUCIDE
4387C	MASTIC SILICONE MENBAP ALU
4960J	MASTIC SILICONE FONGICIL GRIS RAL 7004
7168T	MASTIC SILICONE RAL INOX 300 ML



### COLLE PVC ET COLLE ARMAFLEX

1	2997S	COLLE POUR MANCHON ISOLANT + PINCEAU	0,5L
2	6069K	COLLE POUR TUBE PVC	1L



### MOUSSES

2536R	MOUSSE PU PISTOLABLE IGNIFUGE B1
6349G	MOUSSE PU PISTOLABLE GRAND FROID 750ml
3882E	MOUSSE PU MANUELLE IGNIFUGE 750ML
3881D	MOUSSE PU MANUELLE TOUS SENS 750ML
4973X	MOUSSE PU PISTOLABLE 750ML FIS
4972W	MOUSSE PU MANUELLE 500ML FIS



### PISTOLET APPLICATEUR MOUSSE

2813E PISTOLET APPLICATEUR MOUSSE



# OUTILLAGE

## 225 SDS

### MECHE SDS + 4 TAILLANTS

L	5	6	8	10	12	14	16	18	20	22	24	25
110	1742P	6663Q	6667U	4944T								
160		6664R	6668V	6671Y	6675C	0286X						
165	6109E											
210		6665S	6669W	6672Z	6676D	6678F	6680H					
250								6099U		6103Y	6105A	6107C
260		6666T	6670X	6673A	6684M		6114J					1743Q
310							6681J					
450								6100V		6104Z	6106B	6108D
460			1744R	6674B	6677E	6679G	6682K		6683L			
600					6120R							
1000					6112H							



### MECHE SDS MAX QUADRA

L	12	14	20	22	24	25	28	30	32	35	38	40	45	52
320						2852V								
520			6385L	6149Y	2851U	2853W								
540	6147W	6148X												
570								2857A	4776U	2861E	2862F	2863G	2865J	3389B
670							2856Z							
920			2850T		2854X			2860D				2844M		

## 230 ACCESSOIRES SDS

Ref	MANDRIN AUTO-SERRANT PERCEUSE/VISSEUSE
4097A	1.5 / 13

Ref	PORTE MANDRIN SDS
2525E	



Ref	BURIN PLAT SDS +
3630W	20 X 250 mm 1
Ref	BURIN PIC SDS +
3631X	250 mm 2
Ref	BURIN GOUGE SDS +
3632Y	22 X 250 mm 3



# OUTILLAGE

## 237 FORET HSS COBALT COURT

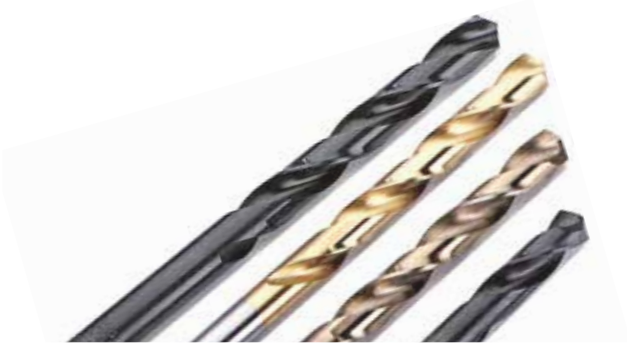

Ø	2	2.5	3	3.2	3.5	4	4.2	4.5
Refs	1387U	1388V	1390X	1389W	1391Y	1392Z	1393A	1394B

Ø	5	5.5	6	6.5	6.8	7	8	8.5
Refs	1395C	1396D	1397E	4854A	5163P	1398F	1399G	5162N

Ø	9	10	10.2	10.5	11	12	13
Refs	3300J	1401J	5164Q	5166S	4855B	4856C	4857D

## 237 FORET HSS COURT



Ø	1	1.5	2	2.5	2.8	3	3.2	3.5
Refs	2720H	2721J	2722K	2723L	4858E	2724M	2725N	2726P

Ø	4	4.2	4.5	4.8	5	5.2	5.5	6
Refs	2727Q	2728R	2729S	4819P	2730T	2731U	2732V	2733W

Ø	6.5	7	7.5	8	8.5	9	9.5	10
Refs	2734X	2735Y	2736Z	2737A	2738B	2739C	2740D	2741E

Ø	10.5	11	11.5	12	12.5	13	13.5	14
Refs	2742F	2743G	2744H	2745J	2746K	2747L	2748M	2749N

Ø	14.5	15	16
Refs	2750P	0115U	0116V

## 237 OUTIL DE COUPE

Refs	COFFRET FORET HSS
0117W	19 forets 1 à 10
0118X	25 forets 1 à 13



Refs	FORET ETAGE
2664Z	4 à 30
2566X	6 à 36



Refs	COFFRET FORET HSS COBALT
3368E	19 forets 1 à 10
6887A	25 forets 1 à 13



Ref	COFFRET FORET HSS HEX 1/4"
6564U	10 forets 3 à 10



Ref	COFFRET 4 TAILLANTS SDS
3945U	





## 226 TREPAN

Refs	KIT TRÉPAN BETON TCT SDS-PLUS
6856T	Ø 68mm
6884X	Ø 65mm



Refs	TREPAN COURONNE 1/8
3251H	Ø 45
3252J	Ø 50
3253K	Ø 60
3254L	Ø 66
3255M	Ø 70
3248E	Ø 80
3249 F	Ø 100
3250G	Ø 110



Ref	ADAPTEUR MEGADRILL SDS MAX
3244A	



Ref	COUPLEUR MEGADRILL 1/8
3246C	



Ref	FORET CENTRAGE CONE
3256N	11 X 120



Ref	KIT EXTRACTION TREPAN
3981G	



Refs	PORTE TREPAN SDS MAX 1/8
4618F	Long 220 mm
3247D	Long 420 mm



Ref	CHASSE CONE CYLINDRIQUE
3980 F	



Ref	ALLONGE MEGADRILL
3245B	280 mm



Ref	PORTE TREPAN ALG SDS 150
4619G	



Refs	COURONNE DIAMANT 1" 1/4	
7096T	Ø 62 X	L. 450 mm
7097U	Ø 76 X	L. 450 mm
5958U	Ø 82 X	L. 450 mm
5957T	Ø 102 X	L. 450 mm
5959V	Ø 112 X	L. 450 mm
5961Y	Ø 127 X	L. 450 mm
5964B	Ø 132 X	L. 450 mm
7098V	Ø 162 X	L. 450 mm



Refs	KIT DE PERCAGE
5969G	KIT DE PERCAGE DIAMANT SX-1100 7 PIECES Ø 06,08,10,12mm +GUIDE+ADAPT M14+CIRE
5970H	KIT DE PERCAGE DIAMANT SX-2500 6 PIECES Ø 20,35,45,55,68 mm + ADAPT M14
4963M	COFFRET DE SCIE TREPAN SPECIAL CARRELAGE 6-8-10-20-32-40-45-50-65-67



Refs	TREPAN ALG
4620H	Ø 25
4621J	Ø 35
4622K	Ø 68



# OUTILLAGE

## 238 SCIE TREPAN ET POINCON



	SCIE TREPAN							
$\varnothing$	16	19	20	22	25	29	32	35
Refs	1844V	2622F	2258B	2623G	2259C	2624H	2260D	2625J
$\varnothing$	38	40	44	51	54	57	64	67
Refs	2626K	2261E	2627L	2628M	1846X	2629N	2263G	2630P
$\varnothing$	76	83	95	105	114	127	140	152
Refs	4091U	2238F	2239G	2240H	2241J	2237E	6360K	6361L
$\varnothing$	160	200	210					
Refs	3666J	6362M	6363N					



Refs	COFFRET 6 SCIES TREPAN
2257A	<b>HSS COBALT</b> 10 pièces 25-32-40-54-68-76 +accessoires
6153C	<b>HSS COBALT</b> 22-29-35-44-51-68 +accessoires

Refs	ARBRE SCIE
2632R	ARBRE SCIE D. 30 ET PLUS queue de 11 mm
2631Q	ARBRE SCIE D. INFERIEUR 30 queue de 11 mm

Refs	FORET CENTRAGE ARBRE
6420W	6.35 X 70
2637W	6.35 X 100

Ref	RALLONGE SCIE 300MM
2633S	



## 246 COFFRETS EMBOUTS

Ref	COFFRET DOUILLE 1/2
4286X	



Ref	COFFRET A CLIQUET 1/4
3026P	



Ref	BOITE EMBOUTS VISSAGE
2309E	



Ref	PORTE-EMBOUT
0401S	1/4 - 1/4 - MAGNETIQUE



Refs	COFFRET EMBOUTS SHOCKWAVE
4891P	15 PIECES <b>A</b>
5931S	32 PIECES <b>B</b>
5932T	56 PIECES <b>C</b>

Refs	NOIX DE SERRAGE 1/4
0001A	5.5
0271G	7
2020D	8
2353A	10
2314K	13

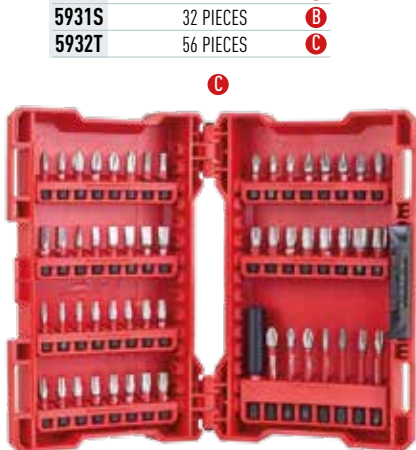

Ref	PORTE EMBOUT 1/4
2825S	SERRAGE RAPIDE



## 215 TRACEUR DE CHANTIER

Refs	PEINTURE FLUO MARQUAGE
4423C	Blanc
3906D	Bleue
3904B	Jaune
3905C	Orange
3903A	Rouge
4424D	Verte



## 216 AEROSOL

Refs	AEROSOLS
6599F	AIR EN SPRAY 520ML AIRPRESS
4108M	ANTI-ADHERENT SOUDURE SANS SILICONE DISTAC WELD 650 ML
2587U	DETECTEUR DE FUITES 650ML SUPER BALL
2589W	GALVA A FROID BRILLANT C042 520ML
7169U	GALVA INOX 520ML INOXSIL C044
2512R	HUILE DE COUPE 650ML ROCUT
6600G	NETTOYANT AIR CONDITIONNE 520ML AIRNET
3015D	PLASTIQUE BRILLE TURBOLUX
2584R	SUPER DEGRIPPANT 520ML PK



## 242 ENROULEUR ET ECLAIRAGE

Ref	LAMPE FRONTALE PETZL TACTIKKA
TACTIKKA	90 ml - 450 lm BATTERIE CORE RECHARGEABLE



Ref	LAMPE FRONTALE PETZL PIXA1
PIXA1	60lm/15ml ATEX zone 2/22 IP67



Ref	FICHE MALE ETANCHE
5259Q	Pour 3G2.5 et 3G1.5



Refs	FICHE FEMELLE A CLAPET
5257N	POUR 3G1.5
5258P	POUR 3G2.5



Refs	ENROULEUR
4917Q	25 ml - IP 44 /2.5
6291W	40 ml - IP 44 /2.5



Ref	PROJECTEUR A LEDS STANDARD
4419Y	50W CABLE DE 3m 4000 lm (EQUIVALENT AU 300W HALOGENE)



Refs	PROJECTEUR LEDS MOBILES
4948X	10W 1000 lm
4950Y	30W 3000 lm



Ref	PROJECTEUR LEDS NOVA 2
7139N	16W 2000 lm



Refs	COFFRET DE CHANTIER
4116V	PIED COFFRET CHANTIER ELEC
4912K	COFFRET DE CHANTIER 4 PC MONO 16A NF PC TETRA 16A ET ARRET D'URGENCE
6595B	COFFRET DE CHANTIER 3 PC 2P+T 16A NF ARRET D'URGENCE ET ARRIVEE CABLE



Ref	CONNECTEUR BATTERIE MILWAUKEE
7140P	POUR PROJECTEUR LEDS NOVA 2





# OUTILLAGE

## 243 DISQUES



Ref	DISQUE DIAMANT BETON ARME
4778W	230 X 2.8 VENTILE

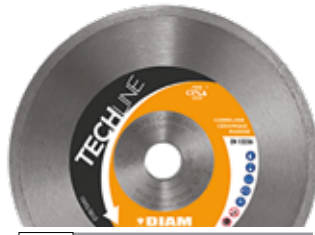

Ref	DISQUE DIAMANT JC
1385S	230 X 1.6
Refs	DISQUE DIAMANT BETON
4779X	115 X 2.2
1380M	125 X 2.2
1382P	230 X 2.4



Refs	DISQUE A TRONCONNER METAUX
2394T	125 X 3.0
2393S	230 X 3 MD



Ref	PLATEAU PONCAGE BETON DIAMANT
5292Z	125 X 22.2



Refs	DISQUE LAMELLES
2916M	ZIR 125 G 40
2915L	ZIR 125 G 60
3 369 F	ZIR 125 G 80
3025N	ZIR 125 G120
2299E	ZIR 125 G80 PLAT



Refs	DISQUE A TRONCONNER INOX
3589D	125 X 1.6 HQE
5639N	125 X 1.0 MP
6334R	125 X 0.75 MP
2900V	230 X 2 MP



Refs	MEULE EBARBER METAUX
0427U	125 X 6.5
2429W	230 X 6.5



Refs	ROULEAU ATELIER
7165Q	G 60 38 X 25
4099C	G 80 38 X 25
4100D	G100 38 X 25
4101E	G120 38 X 25

## 174 ACCROCHAGE



Refs	SANGLE A CLIQUET
3936K	6 ml 35 mm
4160R	9 ml 70 mm
Ref	SANGLE MINUS CEINTURON
3921U	5 ml



Ref	SANDOW 2 CROCHETS
3812G	1000 MM



Ref	CHAINE LONGUE
5046X	DIN5685/C 8mm ZN



Refs	MAILLON RAPIDE ZING
2050K	3.5 mm
3975A	4 mm
6213Q	6 mm
7121U	10 mm



Ref	LUBRIFIANT YELLOW 77
4965P	1L



Refs	LAMPE A SOUDER PIEZO
4509S	LAMPE A SOUDER PIEZO ref 351
4527L	LAMPE SOUDAGE EXPRESS PIEZO MULTIUSAGES ref 8800
4529N	LAMPE A SOUDER EXPRESS CLASSIQUE ref 511

Refs	CARTOUCHE GAZ
4528M	CARTOUCHE BUTANE 190 Gr. ref 8191 POUR 8700, 8800, 8900
4530P	CARTOUCHE BUTANE+PROPANE 340 Gr. ref 555 POUR 511, 531, 2901, 2902

## 241 LAME DE SCIE

Refs	LAME SCIE SABRE BI-METAL
4882E	150 mm
4883F	200 mm
5022X	300 mm



Refs	LAME SCIE SAUTEUSE
6448A	Etui de 3mm LG 220mm - SPÉCIALE PANNEAU SANDWICH
3993U	105mm BOIS 311633 COUPE RAPIDE
4907E	ACIER 3mm LONG. 100mm METAL + PANNEAUX SANDWICHS
4906D	ACIER 6mm LONG. 55mm
3992T	BOIS 5mm LG 50mm DECOUPE DECOUPE ROND
0535G	BOIS 5mm LG 75mm COUPE RAPIDE
0534F	BOIS 5mm STANDART
3016E	BOIS LG 75mm PLAN TRAVAIL
3017F	BOIS LG 75mm SANS ECLAT
3994V	FONTE LG 54mm
2820M	INOX 2 LG 50mm
4733Z	LG 155mm PANNEAU CHAMBRE FROIDE
4881D	METAL LG 75mm ALU 274
0536H	METAL 5mm LG 55mm
2152R	METAL LG 75mm BI-METAL
5021W	NON FERREUX LG 152mm PANNEAU CHAMBRE FROIDE



Ref	LAME SCIE METAUX
0329S	12D



## 168 RUBAN ADHESIF

### RUBAN ÉLECTRICIEN 15 - 10



Refs	Couls	Refs	Couls
4203L	ASSORTIS	4094X	MARRON
4846S	BLANC	3398K	NOIR
3397J	BLEU	3399L	ROUGE
4093W	JAUNE	4095Y	VERT
3400M	JAUNE/VERT		

### RUBAN MASQUAGE PAPIER



Refs	
4443Y	19 X 50
4444Z	24 X 50
4139U	48 X 50

### RUBAN ADHÉSIF PE



Refs	Dim	CouL
4106K	50 X 50	BLEU
4435Q	50 X 33	ORANGE <b>SUP</b>
4107L	50 X 50	ROUGE
5169V	75 X 33	ORANGE
2698T	50 X 33	GRIS
3858E	50 X 33	NOIR
2898U	50 X 33	BLANC

### RUBAN ADHÉSIF TOILE



Refs	Dim	Coul.
5191U	50 X 50	GRIS
4504M	50 X 50	BLEU
4505N	50 X 50	ROUGE
6581M	50 X 50	NOIR
6580L	50 X 50	BLANC

### RUBAN ADHÉSIF ALU



Refs	Larg.	Long.
2893N	50 mm	50 ML
2894P	63 mm	50 ML
2895Q	75 mm	50 ML

#### RUBAN ADHÉSIF ALU ARME

5652B	50mm	50ML
-------	------	------

#### RUBAN ADHÉSIF TOILE BLANC

6580L	50mm	50ML
-------	------	------

### RUBAN MOUSSE ADHÉSIF PP DOUBLE FACE



Refs	
4908F	50 X 25 BLANC
4878A	50 X 100 HAVANE

### BANDE TAPE ISOLANTE K-FLEX



Refs	
6554J	BANDE TAPE ISOLANTE K-FLEX 50 mm X 3 mm Rouleau 15ml
5670V	BANDE ADHESIVE DE DESOLIDARISATION 250 mm / 250 x 4 mm Rouleau 25ml
6562S	BANDE ADHESIVE DE DESOLIDARISATION 330 mm / 330 x 4mm Rouleau 25ml



# OUTILLAGE

## 289 ECHELLE ET ESCABEAU



Ref	PLATEFORME INDIVIDUELLE ROULANTE
7543W	5 MARCHES 1.17m / 3.17m



Refs	ECHELLE ALU TRANSFORMABLE 3 PLANS
4936K	2.28 X 4,83
4937L	3.13 X 6,82
4938M	3.42 X 7,66



Refs	MARCHEPIED ALU
5149A	3 MARCHES
4929C	4 MARCHES
4930D	5 MARCHES
4931E	6 MARCHES
4932F	7 MARCHES
6968K	8 MARCHES

## 290 OUTILLAGE MAÇON

Refs	AUGE
4311Y	PLASTIQUE 13 L
4312Z	PLASTIQUE 25 L



Ref	SEAU TALIAGOM
0398P	13 L



Refs	RACLETTE CAOUTCHOUC BOIS
4362B	27 cm
4361A	44 cm



Ref	RACLETTE A EAU METAL
4360Z	45 cm - ø 24

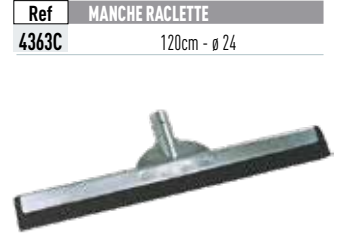

Ref	BALAI CANTONNIER
4367G	32cm CRYNOV - ø 28

Ref	MANCHE BALAI CANTONNIER
4368H	150cm BOIS - ø 28



Refs	BALAI COCO
4369J	5 RANGS 29cm A VIS
0397N	SANS DOUILLE - ø 24
5144V	60cm DOUILLE 28 mm

Ref	MANCHE BALAI COCO
4370K	130cm BOIS - ø 24 - à vis



Ref	GRATTOIR COFFRAGE
4326P	300 X 150 mm - ø 35

Ref	MANCHES GRATTOIR
4327Q	120cm BOIS - ø 35



Refs	SAC POUBELLE
0039Q	110L CARTON 100
6378D	130L CARTON 100



## 290 OUTILLAGE MAÇON

Ref	CISEAU
4344H	300 mm



Ref	POINTEROLLE
4343G	300 mm



Ref	PINCE A DECOFFRER
4348M	800 mm



Refs	COUPE BOULONS	
4349N	450 mm	4399Q 750 mm
4350P	600 mm	4400R 900 mm



Ref	MASSE COUPLE
4331U	4 KG MANCHE TRI-MATIERE

Ref	MANCHE MASSE
4333W	TRI-MATIERE



Refs	MARTEAU RIVOIR
7251E	MARTEAU MENUISIER TRI-MATIERE 500 Gr.
4901Z	MARTEAU RIVOIR TRI-MATIERE 400 Gr.
4337A	MARTEAU RIVOIR TRI-MATIERE 800 Gr.
4338B	MARTEAU RIVOIR TRI-MATIERE 1.5 KG
4336Z	MARTEAU COFFREUR EMMANCHE TRI-MATIERE 700 Gr.



Ref	MASSETTE
4388D	1.2 KG MANCHE TRI-MATIERE

Ref	MANCHE MASSETTE
4330T	TRI-MATIERE



Ref	PIOCHE TERRASSIER
4324M	2,5 kg SANS MANCHE

Ref	MANCHE PIOCHE
4396M	91cm TRI-MATIERE



Ref	PELLE RONDE
4322K	Col de cygne 27 cm SANS MANCHE

Ref	MANCHE PELLE RONDE
6100W	130cm BOIS - ø 38



Refs	TRUELLE BOUT ROND
4395L	ACIER 20
4351Q	ACIER 22
4308V	INOX 22

Ref	TRUELLE LANGUE CHAT
4353S	ACIER 16



Refs	CUTTER BIMAT LAME RETRACTABLE
3937L	18 mm
6113G	25 mm



Ref	PLATOIR LAME COURBE
4600M	



Ref	TALOCHÉ POLYSTYRENE
0399Q	27 X 15 cm



Refs	LAME CUTTER
4089S	ABS 18 mm
6114H	LARGE 25 mm



## 078 OUTILLAGE PLAQUISTE

Ref	SCIE A GUICHET
4376R	DROITE 150 mm



Refs	COUPEAU A ENDUIRE
4357W	12 cm ACIER/BOIS
4356V	15 cm ACIER/BOIS



Ref	CISAILLE TOLE DROITE
4595G	



# OUTILLAGE

## 292 OUTILLAGE ELECTRICIEN

Ref MULTIMETRE DIGITAL  
4135Q



Ref JEU DE 6 TOURNEVIS ULTIMATE  
3788G 5.5 / 6.5 / 8 / PH1 / PH2 / PH3



Ref JEU DE 8 TOURNEVIS ELECTRICIEN  
4459Q

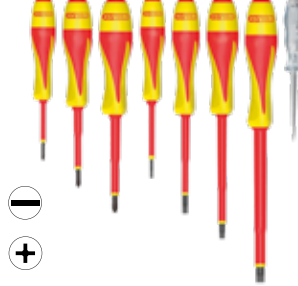

Ref JEU DE 10 TOURNEVIS TRILOBE  
5261S PZ1 / PZ2 / PH1 / PH2 / SL3 / SL4  
SL5.5 / 2xSL6.5 / SL8



Ref JEU DE 6 TOURNEVIS TRILOBE  
5260R PZ1 / PZ2 / SL3 / SL4 / SL5.5 / SL6.5



Refs TOURNEVIS FENTE  
4266B 2.5 X 75  
4267C 4.0 X 100  
4268D 5.5 X 125  
4269E 6.5 X 150

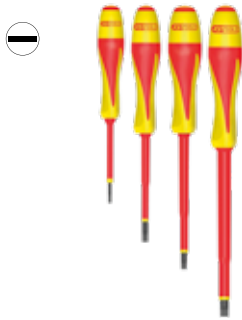

Refs TOURNEVIS PHILLIPS  
4270F PH1 X 80  
4271G PH2 X 100

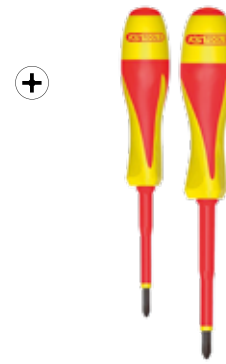

Refs TOURNEVIS POZIDRIV  
4272H PZ1 X 80  
4273J PZ2 X 100  
4274K PZ3 X 150

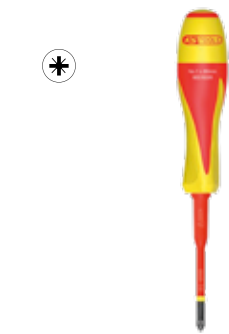

Ref COUPE GAINÉ 45 MM  
4623L PAS DE 2.7 mm



Ref CISEAU ELECTRICIEN GAINÉ  
4228M



Ref COUTEAU ELECTRICIEN 2 LAMES  
5190T



Ref COUTEAU A DEGAINER  
4227L



Ref PINCE A DENUDER GAINÉE 160  
4258T



Ref PINCE UNIVERSELLE GAINÉE 180  
4253N



Refs PINCE MULTIPRISE GAINÉE  
4255Q 240 mm 1  
6505J 300 mm / A VERROUILLAGE 2

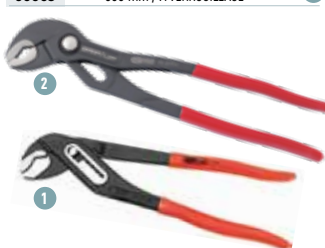

Ref PINCE MULTI VERROU 250  
4570F GRANDE OUVERTURE



Ref PINCE COUPANTE EN BOUT GAINÉE  
4256R



Ref PINCE COUPANTE DIAGONALE ISOLEE  
4941Q



Ref PINCE COUPANTE DIAGONALE GAINÉE  
4257S



Ref PINCE A BEC DEMI ROND COUDE  
5273F



## 292 OUTILLAGE PLOMBIER

Refs	COUPE TUBE PLASTIQUE PC
4627Q	PC 32
4629S	PC 42
4440V	PC 50



Ref	MINI COUPE TUBE CUIVRE 16 MM
4572H	



Ref	COUPE TUBE MINI 3-16
4248H	



Ref	COUPE TUBE CUIVRE 3-32
4250K	



Ref	CALIBREUR
4650P	16 X 2 - 20 X 2 - 25 X 2.5 - 26 X 3 - 32 X 3 mm



Ref	COUPE TUBE CUIVRE ZR
4594F	



Ref	EBAVUREUR TONNEAU INT/EXT
4649N	CU/PVC 40 mm



Ref	EBAVUREUR STYLO
6685Y	UNIVERSEL AVEC LAME FIXE



Ref	CLE VIRAGRIP
4567C	14" ALUMINIUM



Refs	CLE A MOLETTE GRANDE OUVERTURE
4568D	6"
4569E	8"



Refs	CLE A MOLETTE
4252M	150/6"
4245E	200/8"
4246F	250/10"
4247G	300/12"
4134P	375/15"



Ref	MONTURE DE SCIE METAUX
4261W	BI-MATIERE



Ref	COUPE-GAINES TWISTCUT® KNIPEX
7219W	



Refs	PINCE ETAU UNIVERSELLE
4254P	175
4456M	250





# OUTILLAGE

## 292 OUTILLAGE

Refs	CLE MIXTE	
4230P	8	4237W 19
4231Q	10	4238X 21
4232R	11	4239Y 22
4455L	12	4240Z 24
4233S	13	4241A 27
4234T	16	4242B 30
4235U	17	4243C 32
4236V	18	4244D 36



Refs	CLE PIPE DEBOUCHEE 6/6	
4398P	6	4219C 19
4212V	8	4220D 21
4213W	10	4221E 22
4214X	11	4222F 24
4454K	12	4223G 27
4215Y	13	4224H 30
4216Z	16	4225J 32
4217A	17	4226K 36
4218B	18	



Ref	JEU DE 9 CLES MIXTES
4127G	8-9-10-11-12-13-14-17-19 mm



Ref	CLE MALE SIX PANS
4458P	JEU 1.5-10



Ref	CLE MALE TORX - JEU DE 8
6390R	T10 - T50



Ref	CLE MALE SIX PANS LONGUE
4457N	JEU 1.5-10



Ref	JEU DE 10 CLES MIXTES A CLIQUET
6765W	8-10-11-12-13-14-16-17-18-19 mm



Ref	TENAILLE RUSSE 220
4260V	



Ref	TENAILLE RUSSE GAINEE 250
4397N	



Ref	7 CLES A CLIQUET A TETE FLEXIBLE
4820Q	8-17 mm



Refs	CLE MIXTE A CLIQUET REVERSIBLE	
6486P	10 mm	6489S 19 mm
6487Q	13 mm	6490T 22 mm
6488R	17 mm	6491U 24 mm



Ref	JEU DE 2 CLES A CLIQUET 4 EN 1
4821R	



Ref	SAC A BANDOULIERE SMARTBAG XL
3786E	



Ref	CAISSE OUTIL METAL 5 COMPARTIMENTS
4382X	420 x 200 x 200 mm



Ref	CAISSE À OUTILS SCM
3785D	650 x 270 x 272mm





## 239 MESURE ET TRAÇAGE

Refs	NIVEAUX
6861Y	Niveau de poche
4384Z	BLOCK TORPEDO 360 / 25cm Magnétique - 2 fioles + 1 fiole 360°
4638B	TRAPEZOIDAL 40 cm - 2 fioles
4291C	TRAPEZOIDAL MAGNETIQUE 40 cm - 2 fioles <span style="float: right;">1</span>
4383Y	TRAPEZOIDAL 60 cm - 2 fioles
6262Q	TUBULAIRE MAGNETIQUE 100 cm - 2 fioles <span style="float: right;">2</span>
6784U	TUBULAIRE MAGNETIQUE 20 cm - 2 fioles



Refs	TELEMETRE LASER
6956X	TELEMETRE 40m
6957Y	TELEMETRE 60m



Refs	MARQUEUR PICA
3800U	Porte mine PICA DRY
4124D	Marqueur pointe fine PICA NOIR
5679E	Recharge 10 mines
7133G	Marqueur pointe fine PICA ROUGE
7134H	Marqueur pointe fine PICA BLEU
7135J	Porte mine PICA BIG DRY
7136K	Recharge 12 mines



Refs	MESURE BI-MAT MAGNETIC
4605S	5 ml / 27 mm
4603Q	8 ml / 27 mm <span style="float: right;">A</span>
4606T	10 ml / 27 mm

Refs	MESURE TRI-MAT
4602P	3 ml / 16 mm <span style="float: right;">B</span>
6593Y	5 ml / 19 mm <span style="float: right;">C</span>
5276J	8 ml / 25 mm



Refs	MARQUEUR NOIR MILWAUKEE
4852Y	Marqueur noir pointe biseautée
5904Q	Marqueur noir pointe fine



Refs	CRAYON
4192Z	Charpentier rouge
4193A	Tailleur vert

Ref	CRAYON CELLUGRAPHE
5154G	



Ref	CORDEAU A TRACER
4109N	30 ML



Refs	POUDRE A TRACER 360G
3814J	BLEUE
4150F	ROUGE



# PROTECTION

## 400 PROTECTION DES MAINS

Refs	GANT ANTI COUPEURE
6343A	T 8
6344B	T 9
6345C	T 10
6346D	T 11



Refs	GANT FLEUR DE BOVIN
3520J	T 9
3546J	T10



Refs	GANT POLYAMIDE ENDUIT PVC
4834E	T 8
4859F	T 9
4860G	T10



## 410 PROTECTION DU CORPS

Refs	PANTALON SMART
3541D	S
3542E	M
3557V	L
3558W	XL
3559X	XXL



Refs	COMBI. PROOF JETABLE AVEC CAGOULE
3887K	L
2469W	XL
0034K	XXL

Refs	KIT HARNAIS ANTICHUTE
3939N	S/M/L
4945U	XL/XXL



## 430 PROTECTION DU VISAGE

Ref	LUNETTE MASQUE POUSSIERE
3133V	BOLLÉ VENTILÉE - 1

Ref	PROTECTION VISAGE
5192V	POUR MASQUE BOLLÉ - 2



Ref	LUNETTE MASQUE POUSSIERE
3524N	TORNADO



Ref	LUNETTE SLAM
5048Z	INCOLORE



## 440 PROTECTION DE LA TÊTE

Refs	TROUSSE DE SECOURS
0164V	ASEP 20
4884G	INDIVIDUELLE



Refs	CASQUE CHANTIER PE
3571K	BLANC



## 420 PROTECTION DES PIEDS



Refs	BOTTE SECURITE
4303Q	41
4305S	43
4304R	42
4306T	44



Refs	CHAUSSURE HAUTE
5310T	T 39
5311U	T 40
5312V	T 41
5313W	T 42
5314X	T 43
5315Y	T 44
5316Z	T 45
5317A	T 46



Refs	CHAUSSURE BASSE
5302K	T 39
5303L	T 40
5304M	T 41
5305N	T 42
5306P	T 43
5307Q	T 44
5308R	T 45
5309S	T 46

## 450 PROTECTION DE L'OUÏE

Ref	CASQUE ANTI BRUIT
3526Q	27 DB



Ref	CARTON BOUCHONS OREILLES
3577R	150 PAIRES



Ref	BOUCHON OREILLES
3574N	36 DB Sachet de 2



## 460 PROTECTION DES VOIES RESPIRATOIRES

Ref	MASQUE JETABLE FFP1
3581V	boite de 20

Ref	MASQUE JETABLE FFP2 SOUPEPE
3582W	boite de 20

Ref	MASQUE JETABLE FFP3 SOUPEPE
3583X	boite de 5



## 470 HYGIÈNE

Refs	LINGETTES HEAVY DUTY ROUGE BIG WIPES
3789H	120 LINGETTES



Refs	CHIFFON ESSUYAGE
4861H	blanc n°2
6331N	100% COTON - 10KG



## 470 HYGIÈNE

Refs	POMPE DISTRIBUTRICE POUR SAVON
3584Y	POUR SAVON
3657Z	SAVON GSM MICROBIL 4.5 L
3658A	SAVON SPECIAL PEINTURE



Ref	OUATE ESSUYAGE BLANCHE 1000F
0328R	22X24 - 2 rouleaux



Ref	LINGETTE NETTOYANTE X100 DESINFECTANTE
0132M	



## 480 SÉCURITÉ

Ref	FARDIER CYLINDRIQUE
4092V	



Refs	RUBALISE
4381W	ROUGE / BLANC 100m X 50mm
4827X	JAUNE / NOIR 66m X 50mm



Ref	CÔNE SIGNALISATION
4394K	HAUT 50 cm R/B



# CHAMBRE FROIDE

## 7 ACCESSOIRES PANNEAUX

### CONGE D'ANGLE 3 ML



Refs	Désignation
6449B	CONGE D'ANGLE MALE BLANC
6450C	CONGE D'ANGLE FEMELLE
6497A	ANGLE 3D

### U DE SOL



Refs	Largeur	Unité
6525E	40	Pièce
6454G	60	Pièce
6455H	80	Pièce
6456G	100	Pièce
6524D	120	Pièce

### PLINTHE DE PROTECTION BLANCHE



Refs	Hauteur	Unité
6451D	85 mm	Pièce
6611L	100 mm	Pièce

### CONGE D'ANGLE FEMELLE ALU



Ref	Désignation
6630F	CONGE D'ANGLE FEMELLE ALU

### CORNIERE PVC



Ref	Désignation
6632H	CORNIERE PVC 100 X 100 mm

### CORNIERE PVC PLIABLE

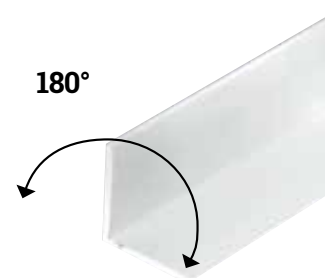

Ref	Désignation
6633J	CORNIERE PVC PLIABLE 50 X 50 mm

## 7 T ALU

### PROFIL T ALU

Refs	Désignation	Dim
5410Y	T35	4 ML
6513S	T35	5 ML
5411Z	T50	4 ML
6549D	T50	5 ML

**CSTB**  
le futur en construction

CONFORME AU  
CAHIER 3626V3



### T DE SUSPENTE

Ref	Dim
4181N	4 ML

**CSTB**  
le futur en construction

CONFORME AU  
CAHIER 3626V3



### T DE SUSPENTE COUPE FEU

Ref	Dim
6636M	4 ML



**COUPE FEU**

CONFORME AU  
CAHIER 3626V3





## 7 VISSERIE SPECIALISEE

### VIS AUTOPERCEUSE



Refs	Longueur	Unité
2761A	4.2 X 16 GALVA	C
2831Y	4.2 X 19 GALVA	Pièce
5229P	4.2 X 19 INOX (qui perce l'inox)	Pièce
2832Z	4.2 X 25 GALVA	Pièce

### VIS AUTOPERCEUSE 5.5X25

Possibilité d'autres couleurs spécifiques



Refs	Longueur	Couleur
6585R	5.5 X 25	RAL 7016
6586S	5.5 X 25	RAL 9005
6587T	5.5 X 25	RAL 1015
6588U	5.5 X 25	RAL 9006
6589V	5.5 X 25	RAL 9010

### VIS AUTOPERCEUSE



Refs	Longueur	Unité
3891P	4.2 X 16 BLANC	Pièce
4764G	4.2 X 19 BLANC	Pièce

### CAVALIER POUR PANNEAU

DIFFÉRENTS MODÈLES SELON VOTRE PANNEAU



Ref	Désignation
6624Z	CAVALIER POUR PANNEAU

### VIS AUTOPERCEUSE DOUBLE FILET BLANC 9010

existe aussi en version INOX



Refs	Longueur	Perçage	Serrage
5137N	5,5 X 85	4 à 12	35-50
6459M	5,5 X 98	2 à 5	50-78
5138P	5,5 X 105	4 à 12	38-70
5139Q	5,5 X 120	2 à 5	60-100
4804Y	5,5 X 130	2 à 5	70-110
5140R	5,5 X 130	4 à 12	61-95
4805Z	5,5 X 150	2 à 5	70-130
5141S	5,5 X 150	4 à 12	61-115
5142T	5,5 X 175	4 à 12	85-140
6063F	5,5 X 180	2 à 5	100-160
6060C	5,5 X 190	4 à 12	100-150
6064G	5,5 X 200	2 à 5	120-180
6061D	5,5 X 210	4 à 12	120-170
6460N	5,5 X 230	2 à 5	150-210
5143U	5,5 X 240	4 à 12	152-200
6062E	5,5 X 285	4 à 12	200-245

**TOUT COLORIS  
DISPONIBLE  
EN 72H**

**NJANCIER STANDARD\*** (Les couleurs imprimées sont données à titre indicatif) :

1015 Jaune sable	7015 Gris ardoise	7042 Gris trafic	8005 Noir
2016 Gris béton	7016 Gris anthracite	8012 Rouge tuile	9008 Aluminium
3009 Ardoise	7032 Gris graphite	8014 Brun macao	9007 Gris persan
4011 Vert réséda	7035 Gris clair	8001 Blanc papyrus	8010 Blanc
5021 Vert tilleul	7037 Gris poussière	9002 Gris pierre	Nuage 4730
7008 Laiton			

## 7 MASTIC CHAMBRE FROIDE

### MASTIC FONGIFIX

Refs	Désignation
5327N	FONGIFIX BLANC 310ml
3876Y	FONGIFIX TRANSLUCIDE



### MASTIC BUTYFIX

Ref	Désignation
4785D	BUTYFIX BLANC





# CHAMBRE FROIDE

## 7 LES SUSPENTES

### ECLISSE POUR T ALU 35T - 50T



Ref	Désignation
6289U	ECLISSE POUR T ALU 35T-50T

### COULISSE POUR T ALU AVEC RUPTURE THERMIQUE



Refs	Diam
6548C	M10
6512R	M8

### CHAPPE DE TRINGLERIE



Ref	Diam	Longueur
6511Q	M10	40 mm

### KIT CEINTURAGE POUTRE BETON 41



Ref	Longueur	Unité
4055G	500 mm	Pièce

### BOUCHON INSERT M 10 BLANC 9010



Ref	Unité
6326H	Pièce

### RONDELLE INSERT M 10 BLANC 9010



Ref	Unité
6327J	Pièce

### SUSPENTE RAPIDE IPN

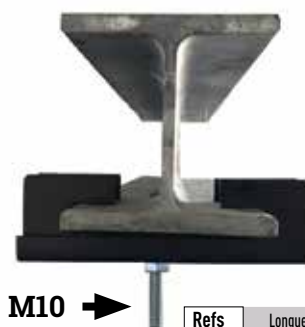

M10 →

Refs	Longueur	Unité
6421X	110 mm	Pièce
6422Y	240 mm	Pièce

### PIÈCE DE RÉGLAGE ORIENTABLE

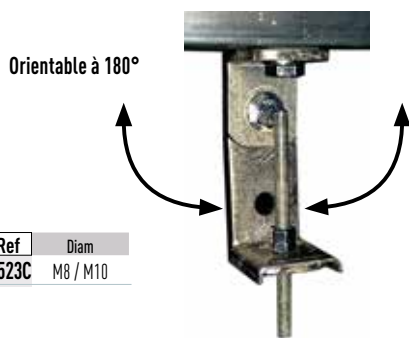

Orientable à 180°

Ref	Diam
6523C	M8 / M10

### PIECES DE REGLAGE FIXE

Refs	Longueur	Unité
6263R	120 mm	Pièce
6510P	50 mm	Pièce



M10

M10

### SUSPENTE COMPLETE AVEC PIECE DE REGLAGE 41X41



Refs	Longueur
6433K	300 mm
6434L	400 mm
6435M	500 mm

### ROTULE

Refs	Diam
5906S	M8
5907T	M10



## 7 ISOLATION CHAMBRES FROIDES

### ISOLANT DE SOL

Pour toute étude  
nous contacter

Refs	Désignation
6481J	215 KPA
6640R	300 KPA
6641S	420 KPA



### PRIMAIRE BITUME E



Ref	Désignation
6642T	PRIMAIRE BITUME

### POLYANE 200 MICRON



Ref	Désignation
6250C	POLYANE 200 MICRON

### MANCHON ISOLANT POUR TIGE FILETEE



Pour tige filetée  
M8/M10

Ref	Unité
6475C	Pièce

### PARE VAPEUR TURBO STICK



Ref	Désignation
6643U	PARE VAPEUR TURBO STICK



**POINT FIX**

**NOS AGENCES AU SERVICE  
DES PROFESSIONNELS**

**AVIGNON - 84**

29, AVENUE DE L'ORME FOURCHU  
TÉL. 04 90 89 45 45  
contact.avignon@pointfix.eu

**AUBAGNE - 13**

Z.I. DES PALUDS - 146, RUE DES 4 TERMES  
TÉL. 04 42 01 63 40  
contact.aubagne@pointfix.eu

**MONTPELLIER - 34**

10, RUE ANTOINE DE ST-EXUPÉRY  
TÉL. 04 99 62 87 41  
contact.montpellier@pointfix.eu

**www.pointfix.fr**